



A419ABG-3C Electronic Temperature Control

Application

IMPORTANT: Use this A419ABG-3C Electronic Temperature Control only as an operating control. Where failure or malfunction of the electronic temperature control could lead to personal injury or property damage to the controlled equipment or other property, additional precautions must be designed into the control system. Incorporate and maintain other devices, such as supervisory or alarm systems or safety or limit controls, intended to warn of or protect against failure or malfunction of the electronic temperature control.

IMPORTANT : Utiliser ce A419ABG-3C Electronic Temperature Control uniquement en tant que dispositif de contrôle de fonctionnement. Lorsqu'une défaillance ou un dysfonctionnement du electronic temperature control risque de provoquer des blessures ou d'endommager l'équipement contrôlé ou un autre équipement, la conception du système de contrôle doit intégrer des dispositifs de protection supplémentaires. Veiller dans ce cas à intégrer de façon permanente d'autres dispositifs, tels que des systèmes de supervision ou d'alarme, ou des dispositifs de sécurité ou de limitation, ayant une fonction d'avertissement ou de protection en cas de défaillance ou de dysfonctionnement du electronic temperature control.

The A419 Electronic Temperature Control is a single-stage, electronic temperature control. Pre-wired cords with plug and receptacle ends are provided for quick and simple installation.

The control features a lockable, three-button touchpad for setup and adjustment and a Liquid Crystal Display (LCD) which displays the sensed temperature and other control functions. A front panel Light-Emitting Diode (LED) indicates the output relay status. The control has a setpoint range of -30 to 212°F (-34 to 100°C) and is available in 120 VAC models. See the *Technical Specifications* section.

The A419 control has heating and cooling modes with adjustable setpoint and differential, an adjustable anti-short cycle delay, and a temperature offset (setback) function. The control provides remote

sensing capability, and electronic accuracy in a Type NEMA 1 high-impact plastic enclosure suitable for surface or DIN rail mounting. The temperature sensor supplied with the control is interchangeable with compatible Johnson Controls/PENN® A99 temperature sensors.

FCC Compliance

This equipment has been tested and found to comply with the limits for a Class A digital device pursuant to Part 15 of the FCC Rules. These limits are designed to provide reasonable protection against harmful interference when the equipment is operated in a commercial environment. This equipment generates, uses, and can radiate radio frequency energy and, if not installed and used in accordance with the instruction manual, may cause harmful interference to radio communications. Operation of this equipment in a residential area is likely to cause harmful interference, in which case the user will be required to correct the interference at his/her own expense.

Canadian DOC Compliance

This digital apparatus does not exceed the Class A limits for radio noise emissions from digital apparatus set out in the Radio Interference Regulations of the Canadian Department of Communications.

Installation

Refer to the following guidelines, procedures and illustrations when installing an A419 control.

Parts Included

Pre-wired cords with plug and receptacle ends are provided for quick and simple installation.

Each A419 control includes a Johnson Controls/PENN A99 temperature sensor. The sensor may be removed and replaced with any compatible Johnson Controls® A99 temperature sensor, or the wire leads on the sensor may be extended.

See the *Mounting* and *Wiring* sections for additional guidelines and restrictions when mounting and wiring the control.

Dimensions

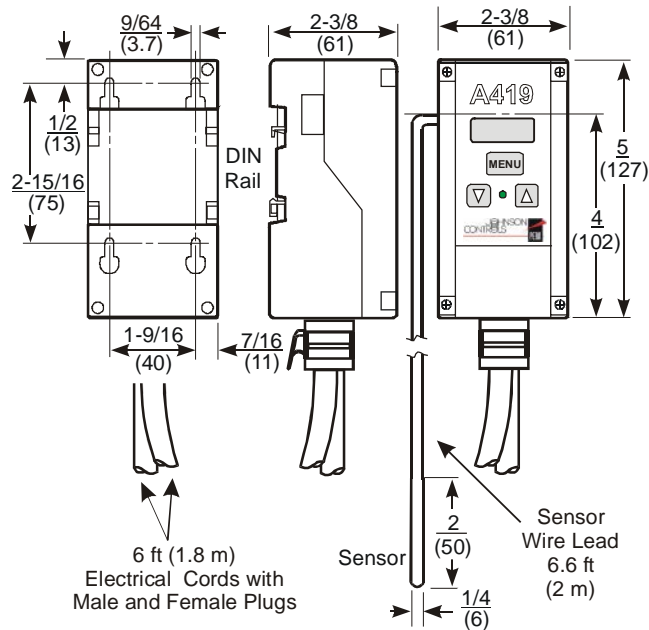

Figure 1: Dimensions, in. (mm)

Mounting

An A419 control has a standard high-impact plastic NEMA 1 enclosure. The A419 control is not position sensitive but should be mounted for convenient wiring and adjustment.

Wiring



WARNING: Risk of Electric Shock.

Disconnect or isolate all power supplies before making electrical connections. More than one disconnection or isolation may be required to completely de-energize equipment. Contact with components carrying hazardous voltage can cause electric shock and may result in severe personal injury or death.

AVERTISSEMENT : Risque de décharge électrique. Débrancher ou isoler toute alimentation avant de réaliser un branchement électrique. Plusieurs isolations et débranchements sont peut-être nécessaires pour couper entièrement l'alimentation de l'équipement. Tout contact avec des composants conducteurs de tensions dangereuses risque d'entraîner une décharge électrique et de provoquer des blessures graves, voire mortelles.

All wiring must conform to the National Electrical Code and local regulations.

Observe the following guidelines and refer to Figure 2 and Table 1 when wiring the sensor to the A419 control.

- Wire insulation rating must be 90°C, minimum.
- Temperature sensor signals may be affected by electrical interference. When extending sensor cable beyond 50 ft (15.2 m), use a twisted-pair, shielded cable to reduce electrical interference.
- A99 temperature sensors are not polarity sensitive. Wire the leads to (+) SEN and (-) COM on the sensor terminal block (TB3). See Figure 2. Keep the leads between the control and sensor as short as possible/practical in your application. The additional resistance in long sensor leads creates error between the actual temperature and the displayed temperature. Refer to Table 1 when extending sensor leads.

Table 1: Maximum Recommended Sensor Cable Lengths and Wire Sizes

Wire Gauge	Maximum Sensor Cable Length* feet (meters)
16 AWG	500 (150)
18 AWG	300 (100)
20 AWG	200 (60)
22 AWG	125 (40)

* At the listed maximum cable lengths, there is less than 1F° (0.6C°) error in the actual temperature vs. displayed temperature.

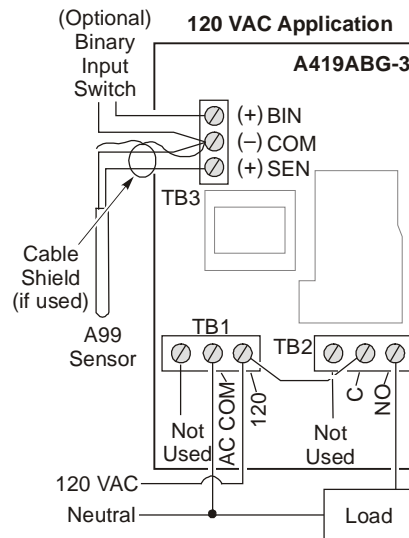

Figure 2: Typical 120 VAC Application Wiring

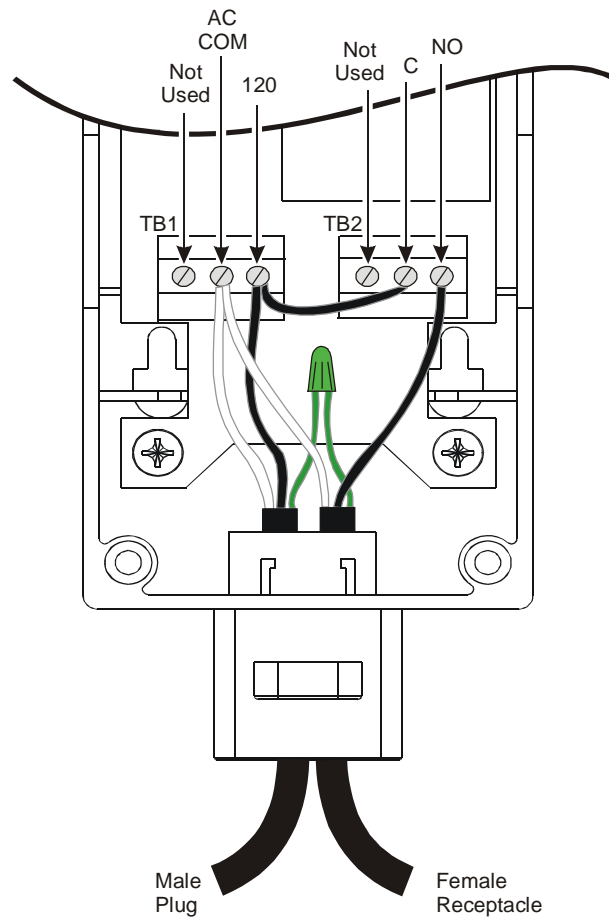

Figure 3: Factory Power Wiring

Setup and Adjustments



WARNING: Risk of Electric Shock.

Disconnect or isolate all power supplies before making electrical connections. More than one disconnection or isolation may be required to completely de-energize equipment. Contact with components carrying hazardous voltage can cause electric shock and may result in severe personal injury or death.

AVERTISSEMENT : Risque de décharge électrique. Débrancher ou isoler toute alimentation avant de réaliser un branchement électrique. Plusieurs isolations et débranchements sont peut-être nécessaires pour -couper entièrement l'alimentation de l'équipement. Tout contact avec des composants conducteurs de tensions dangereuses risque d'entraîner une décharge électrique et de provoquer des blessures graves, voire mortelles.

IMPORTANT: To ensure that the output relay operates as intended, verify that all three of the jumpers are positioned properly for the application before powering the A419 control.

IMPORTANT: The touchpad cannot be unlocked without a jumper installed across the P5 jumper pins. Do not discard jumpers in case they are required in the future. See **Figure 4** and **Figure 5**.

Positioning the Jumpers

The **P5 jumper** position determines if the touchpad is locked or unlocked.

The **P4 jumper** pin block has two pairs of jumper pins. The top pair of pins (JUMP1) determines if the control is set for Heating or Cooling mode. The bottom pair of pins, (JUMP2) establishes whether Setpoint is at cut-in or at cutout. See Table 2 and Figure 5.

To position a jumper in the **Installed** position, place the jumper on both pins, which closes the circuit between the pins. To position a jumper in the **Removed** position, place the jumper on one pin only. See Figure 4.

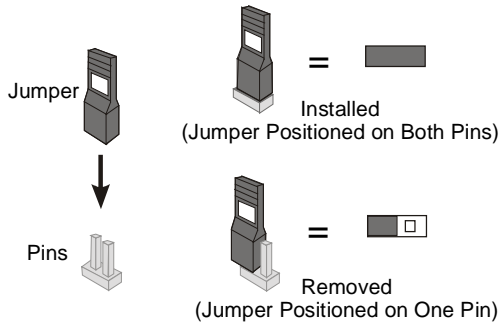

Figure 4: Positioning the Jumpers

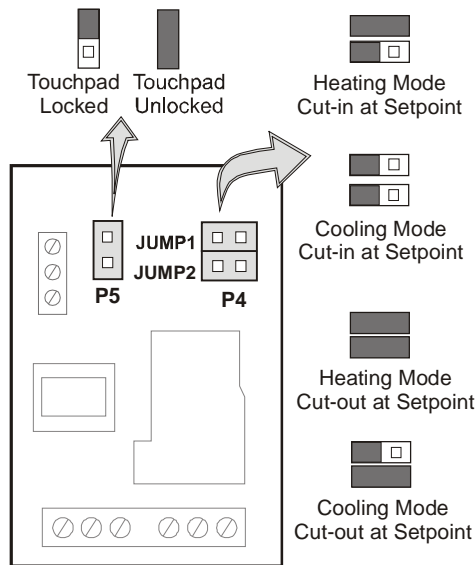

Figure 5: Jumper Positions and Control Settings

Table 2: Jumper Designations, Jumper Positions, and Control Settings

Function	Jumper Pins Designation on Control	Setting	Jumper Position	Factory Default Setting (and Jumper Position)
Cooling/Heating Operating Mode	JUMP1 (Top Pair of Pins on Block P4)	Cooling Mode	Removed	Cooling Mode (Jumper Removed)
		Heating Mode	Installed	
Setpoint at Cut-in or Cutout	JUMP2 (Bottom Pair of Pins on Block P4)	Setpoint at Cut-in	Removed	Cut-in (Jumper Removed)
		Setpoint at Cutout	Installed	
Touchpad Lock	P5	Locked	Removed	Unlocked (Jumper Installed)

The A419 Control Functions

Setpoint (SP) establishes the temperature value at which the equipment is switched on or off, depending on the user selected mode of operation. Setpoint range is -30 to 212°F or -34 to 100°C (in 1-degree increments).

If Setpoint mode is set to cut-in, setpoint is the temperature value at which the control closes the Normally Open (N.O.) contacts. If Setpoint mode is set to cutout, setpoint is the temperature at which the N.O. contacts open.

Differential (dIF) establishes the difference in temperature between the cut-in value and cutout value. The differential is set relative to Setpoint and may be set from 1 to 30 F° or C° (in 1-degree increments).

Anti-Short Cycle Delay (ASd) establishes the minimum time that the output relay remains de-energized before the next on-cycle. The **ASd** does not allow the output relay to re-energize until the programmed time delay has elapsed. The delay is activated when the control is first turned on and every time an on-cycle ends. When the delay is activated, the LCD alternately flashes the sensor temperature and **ASd**. The Anti-short Cycle Delay range is 0 to 12 minutes (in 1-minute increments).

Sensor Failure Operation (SF) establishes how the A419 control's output-relay operates the equipment in the event of a sensor or sensor wiring failure. The user may select to run the equipment continuously or to shut it down. When the control detects a sensor circuit failure, the LCD flashes **SF** alternately with **OP** (if the sensor circuit is open), or **SH** (if the sensor circuit is shorted). Before indicating a failure, the control implements a 1-minute delay, which allows verification of failure condition and avoids nuisance failure indications.

Temperature Offset (OFS) establishes a set secondary **Setpoint** and **Differential** values that may be invoked to control an application when a circuit is closed between the binary input (**BIN**) and common (**COM**) terminals (and **BIN** appears on the display). See Figure 6. Offset range is 0 to 50F° or C° (in 1-degree increments). A typical application might use a switching time clock to invoke night-setback temperature settings.

IMPORTANT: Make sure the Touchpad Lock jumper is installed (unlocked) before attempting to adjust the A419 control functions. See **Figure 5**.

Changing the A419 Control Temperature Units

The A419 control is factory set to display Fahrenheit temperature. To change to Celsius, press **Up** and **Down** (arrows) simultaneously. Press them again to display Fahrenheit units. Verify that the control is displaying the desired temperature units before setting the Setpoint.

Setting the A419 Control Setpoint Value

To view and adjust Setpoint, follow these steps:

1. Press and hold MENU (about 2 seconds) until the display flashes SP.
2. Press MENU again to display the existing setpoint value.
3. Press Up or Down (arrows) to change the setpoint value.
4. Press MENU again to save the new value. The display returns to the sensed temperature.

If no setup entry is made for 30 seconds, the control reverts to the (normal) temperature display.

IMPORTANT: If MENU is not pressed after changing the setpoint value, the control reverts to the previously programmed setpoint value.

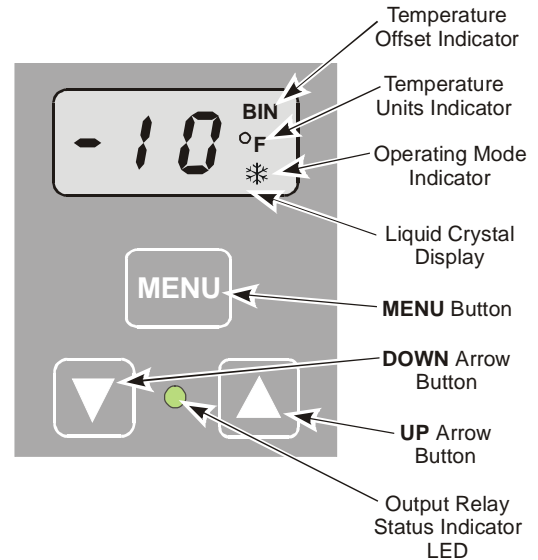

Figure 6: Liquid Crystal Display, Touchpad, and LED Indicator

Table 3: Display Symbols, Control Function, Ranges, Units, Values, and Factory Settings

Display Symbol	Control Function	Range – Units/Value	Factory Set Value
SP	Setpoint*	-30 to 212 – °F (-34 to 100 – °C)	30
dIF	Differential*	1 to 30 – (F° or C° in 1-degree increments)	5
ASd	Anti-short Cycle Delay	0 to 12 – (in 1-minute increments)	1
OFS	Temperature Offset	0 to 50 (F° or C° in 1-degree increments)	0
SF	Sensor Failure Operation	(No range) – 0 = output relay de-energized 1 = output relay energized	1
F or C	Temperature Units	(No range) – F° or C°	F°
BIN	Temperature Offset Indicator	(No range) – BIN is displayed and the A419 control operates on the secondary setpoints when the circuit between the BIN and COM terminals is closed.	N/A
❄ or 🔥	Cooling or Heating Mode of Operation	(No range) – ❄ (Cooling Mode) is displayed when the Jump1 jumper is removed. 🔥 (Heating Mode) is displayed when the Jump1 jumper is installed.	❄ Cooling Mode

* The sum of the Setpoint and Differential values must be within the Setpoint range, or the control may not function properly.

Setting the Other A419 Control Functions

To set the Differential, Anti-short Cycle Delay, Temperature Offset, or Sensor Failure operation, use the following method:

1. Press and hold MENU until the display changes to flashing SP. (This takes about 2 seconds.)
2. Press Up or Down (arrows) repeatedly until the desired function is displayed. (See Figure 6.)
3. Press MENU to display the function's current value.
4. Press Up or Down (arrows) until the desired value is displayed.
5. Press MENU to save the new value. The display returns to the sensor temperature.

IMPORTANT: If MENU is not pressed after changing the settings, the new settings are not saved and the control reverts to the previously programmed setting values.

Note: If no setup entry is made for 30 seconds, the control reverts to the (normal) temperature display.

Note: Any saved A419 control settings are **non-volatile** and remain in the control's memory during power interruptions.

IMPORTANT: Do not set Setpoint and Differential values which (when totaled) fall out of A419 control's Setpoint range (-30 to 212°F [-34 to 100°C]). The control will not function properly if Cut-in or Cutout values are outside of the control's Setpoint range.

Checkout

Before applying power, make sure installation and wire connections are correct for your application. Then power, operate, and observe the system and A419 control for at least three complete operating cycles before leaving the installation.

Troubleshooting



WARNING: Risk of Electric Shock.

Do not touch any exposed metal parts with anything other than properly insulated tools or insulated probes of the digital voltage meter. Failure to use properly insulated tools and probes may result in severe personal injuries or death.

AVERTISSEMENT : Risque de décharge électrique. Ne jamais toucher une partie métallique exposée avec tout élément autre que des outils correctement isolés ou les sondes isolées du voltmètre numérique. L'utilisation d'outils et de sondes incorrectement isolés risque de provoquer des blessures graves, voire mortelles.

If the control system does not function properly, verify that the control is wired, and set up properly. If the problem persists, use the following procedures to determine the cause of the problem:

IMPORTANT: Follow these troubleshooting procedures in the order presented. Do not skip any of the steps in the procedures.

1. **Check for proper voltage to the A419 control.**
 - a. Remove the cover by loosening the four captive cover screws.
 - b. Use a reliable AC voltmeter to check the voltage between the **COM** and **120V** terminals on terminal block **TB1**. Refer to Figure 2.
 - c. The voltage must be between 102 and 132 VAC for 120 VAC applications.
 - d. If the voltage reading is not within the required range, check the power source and input power wires for problems.
2. **Check for proper sensor operation.**
 - a. Disconnect all power sources to control.
 - b. Using an accurate thermometer, take a temperature reading at the sensor location.
 - c. Disconnect the sensor from the control.
 - d. Using an ohmmeter, measure the resistance across the two sensor leads while the sensor is at the temperature taken in Step 2b.
 - e. Consult Figure 7 to verify that the measured temperature and resistance conform to established temperature and resistance values.

- f. If the measured values conform to the values in Figure 7, proceed to Step 3.
- g. If the sensor's measured resistance value is substantially different from the expected value for that temperature, check the sensor wiring. If sensor wiring is okay, replace the sensor.

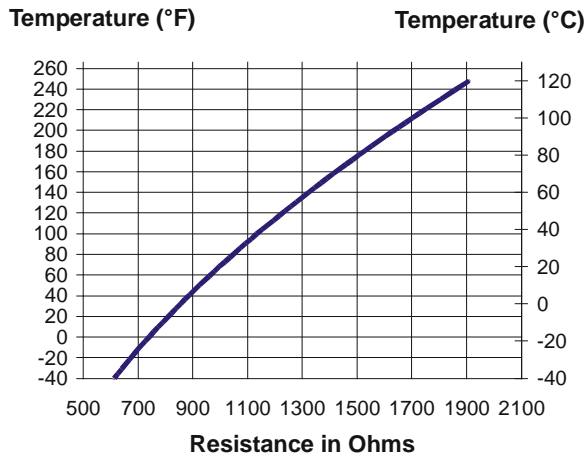

Figure 7: Temperature vs. Sensor Resistance

3. Check the A419 for proper operation.

Note: Perform *Troubleshooting* Steps 1 and 2 before performing this step.

- a. Disconnect the load from the output relay terminals.

- b. Ensure that the Touchpad Lock jumper is installed, so that the touchpad is unlocked.
- c. Reconnect the sensor leads and supply power to the control.
- d. Replace the cover.
- e. Check the control settings for proper values.
- f. Press and hold MENU until Setpoint appears. (This takes about 2 seconds.)
- g. Press the **Up** and **Down** (arrows) to change the Setpoint temperature above and below the sensor temperature until the relay energizes and de-energizes as shown in Figure 7.

Note: If the anti-short cycle delay has a set delay-time value greater than 0 minutes when the control is powered On, the relay does not energize until the time delay has elapsed.

- h. If the output relay does **not** perform as indicated in Figure 7, replace the A419 control.
- i. If proper operation of the A419 control is verified, reconnect the load and consult the equipment manufacturer's instructions for troubleshooting the controlled equipment.

Fault Codes

If the LCD displays an alarm or fault code (**SF** or **EE**), consult Table 5 for explanation.

Table 4: A419 Output Relay Operation in Different Operating Modes

Setpoint Mode	Operating Mode	Output Relay Is Energized (closing the NO and COM contacts) at...	Output Relay Is De-Energized (opening the NO and COM contacts) at...
Cutout	Cooling	Setpoint plus differential	Setpoint
	Heating	Setpoint minus differential	Setpoint
Cut-in	Cooling	Setpoint	Setpoint minus differential
	Heating	Setpoint	Setpoint plus differential

Table 5: Fault Codes Defined

Fault Code	Definition	System Status	Solution
SF flashing alternately with OP	Open temperature sensor or sensor wiring	Output functions according to the selected sensor failure mode (SF setting)	See <i>Troubleshooting</i> section. Cycle power to reset the control.
SF flashing alternately with SH	Shorted temperature sensor or sensor wiring	Output functions according to the selected sensor failure mode (SF setting)	See <i>Troubleshooting</i> section. Cycle power to reset the control.
EE	Program failure	Output is off	Reset the control by pressing MENU . If problems persist, replace the control.

Repairs and Replacement

Do not attempt to repair or recalibrate the A419 temperature control. In case of a defective or improperly functioning control, contact your nearest Authorized Johnson Controls/PENN distributor or sales representative.

When contacting your Johnson Controls/PENN distributor, have the model number of the control available. This number can be found on the label inside the cover of the control.

Ordering Information

Refer to Table 6 to order sensors, mounting hardware and other accessories used to install A419 controls. Contact your nearest Johnson Controls/PENN distributor or sales representative to order these products.

Table 6: A419 Controls Accessories

Product Code Number	Description
A99BB-200	Temperature Sensor: PTC Sensor with 6-1/2 ft (2 m) Non-shielded 2-Wire Lead
BKT287-1R	DIN Rail: 12 in. (305 mm) long
BKT287-2R	DIN Rail: 36 in. (914 mm) long
PLT344-1R	End Clamps for DIN Rail Mounting
CLK350-2C	7-Day Programmable Digital Clock for activating Binary Offset
WEL11A-601C	Immersion Well for Mounting Sensor in Liquid Applications

Technical Specifications

Product	A419ABG-3C Electronic Temperature Control	
Setpoint Range	-30 to 212°F (-34 to 100°C)	
Differential Range	1 to 30F° (1 to 30C°)	
Supply Voltage	120 VAC, 60 Hz	
Power Consumption	1.8 VA Maximum	
SPST Output Relay Contacts Electrical Ratings	Full Load Amperes N.O.:	12 A
	Locked Rotor Amperes N.O. :	72 A
	Non-inductive Amperes N.O.:	10 A
	Pilot Duty:	125 VA @ 120 VAC
Sensor Type	PTC Sensor with 6.6 ft (2.0 m) leads	
Control Ambient Temperature	Operating:	-30 to 140°F (-34 to 60°C)
	Shipping:	-40 to 185°F (-40 to 85°C)
Ambient Humidity	0 to 95% RH Noncondensing; Maximum Dew Point: 85°F (29°C)	
Control Enclosure Material	Case and Cover: NEMA 1 - High-Impact Thermoplastic	
Agency Listings	UL: File E27734; CCN's XAPX (US), XAPX7 (Canada)	
	FCC: CFR 47, Part 15, Class A. DOC, Class A	

The performance specifications are nominal and conform to acceptable industry standards. For application at conditions beyond these specifications, contact Application Engineering at 1-800-275-5676. Johnson Controls, Inc. shall not be liable for damages resulting from misapplication or misuse of its products.



Building Efficiency
507 E. Michigan Street, Milwaukee, WI 53202

® Johnson Controls and PENN are registered trademarks of Johnson Controls, Inc. in the United States of America and/or other countries. All other trademarks used herein are the property of their respective owners. © Copyright 2014 by Johnson Controls, Inc. All rights reserved.