



## How To Use The Data Brochure

This brochure is organized into four main sections. They are: 1) *Sequence of Operation*, 2) *Installation*, 3) *Control Settings*, and 4) *Troubleshooting*. The *Sequence of Operation* section has three sub-sections. We recommend reading Section A: *General Operation* of the *Sequence of Operation*, as this contains important information on the overall operation of the control. Then read the sub-sections that apply to your installation. For quick installation and setup of the control, refer to the *Installation* section, *DIP Switch Setting* section, followed by the *Quick Setup* section.

The *Control Settings* section (starting at *DIP Switch Setting*) of this brochure, describes the various items that are adjusted and displayed by the control. The control functions of each adjustable item are described in the *Sequence of Operation*.

## Table of Contents

<b>User Interface</b> .....	<b>Pg 2</b>	<b>Quick Setup</b> .....	<b>Pg 11</b>
<b>Description of Display Elements</b> .....	<b>Pg 3</b>	<b>Control Settings</b> .....	<b>Pg 12</b>
<b>Sequence of Operation</b> .....	<b>Pg 3</b>	<b>View Menu</b> .....	<b>Pg 12</b>
<b>Section A: General Operation</b> .....	<b>Pg 3</b>	<b>Adjust Menu</b> .....	<b>Pg 12</b>
<b>Section B: Mixing</b> .....	<b>Pg 4</b>	<b>Testing and Troubleshooting</b> .....	<b>Pg 14</b>
<b>Section C: Boiler Operation</b> .....	<b>Pg 7</b>	<b>Error Messages</b> .....	<b>Pg 15</b>
<b>Installation</b> .....	<b>Pg 8</b>	<b>Technical Data</b> .....	<b>Pg 16</b>
<b>DIP Switch Setting</b> .....	<b>Pg 10</b>	<b>Limited Warranty</b> .....	<b>Pg 16</b>

Reference Material: Essay E 003 "Characterized Heating Curve and Reset Ratio"  
Essay E 021 "Mixing Methods and Sizing of Variable Speed Injection Pumps"

## User Interface

The 356 uses a Liquid Crystal Display (LCD) as the method of supplying information. You use the LCD in order to set up and monitor the operation of your system. The 356 has three push buttons (**Item**, **▲**, **▼**) for selecting, viewing, and adjusting settings. As you program your control, record your settings in the ADJUST menu table which is found in the second half of this brochure.

### **Item**

The abbreviated name of the selected item will be displayed in the item field of the display. To view the next available item, press and release the **Item** button. Once you have reached the last available item, pressing and releasing the **Item** button will return the display to the first item.



### **Adjust**

To make an adjustment to a setting in the control, press and hold simultaneously for 1 second, the **Item**, **▲** and **▼** buttons. The display will then show the word ADJUST in the top right corner. Then select the desired item using the **Item** button. Finally, use the **▲** and / or **▼** button to make the adjustment.

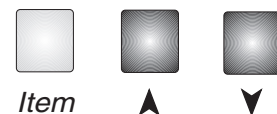

To exit the ADJUST menu, either select the ESC item and press the **▲** or **▼** button, or leave the adjustment buttons alone for 20 seconds.



When the **Item** button is pressed and held in the VIEW menu, the display scrolls through all the control adjust items in both access levels.

Additional information can be gained by observing the status field and pointers of the LCD. The status field will indicate which of the control's outputs are currently active. Most symbols in the status field are only visible when the VIEW menu is selected.

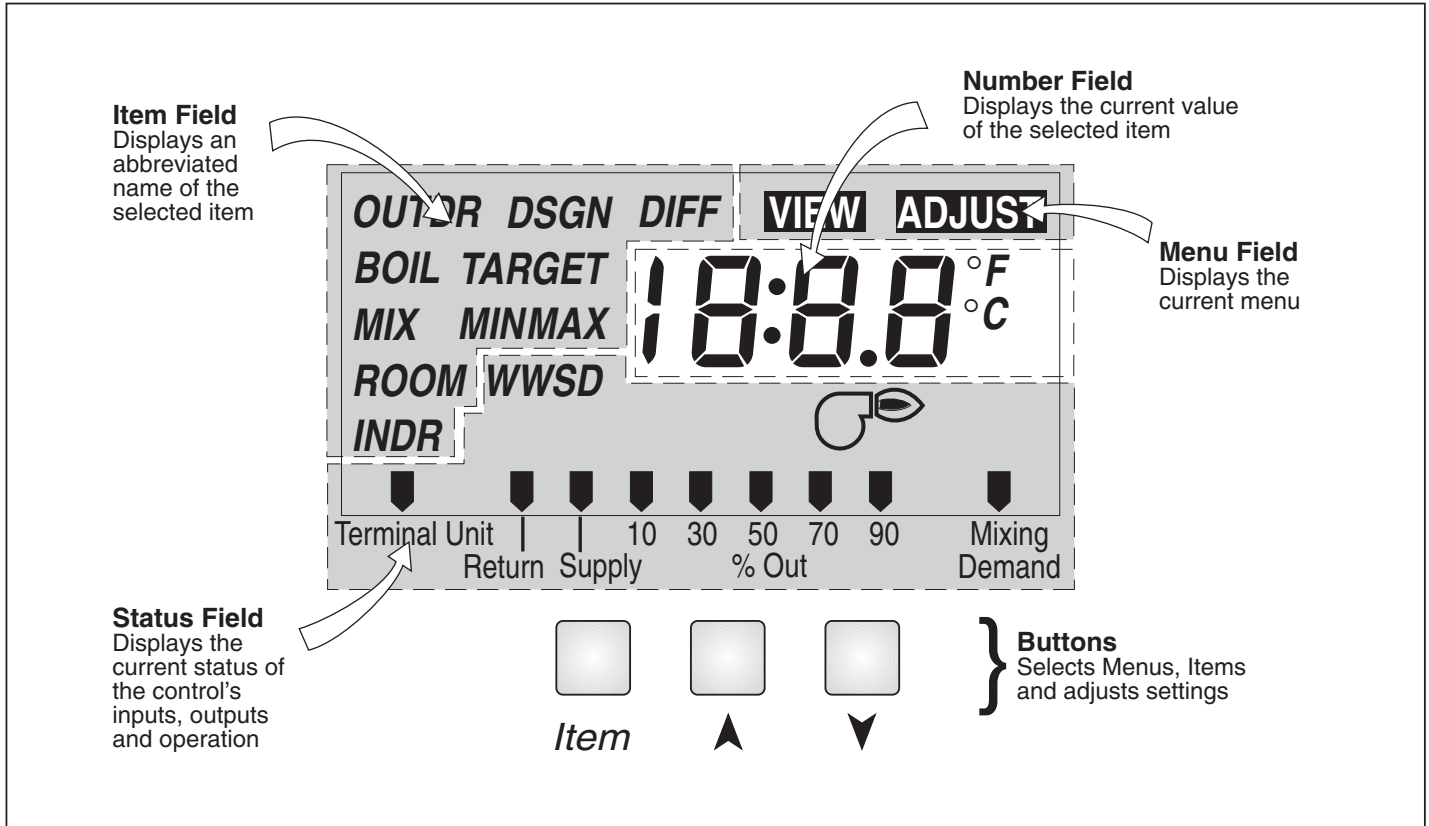
## Display



## Symbol Description

	<b>Burner</b> Displays when the boiler relay is turned on.		<b>Pointer</b> Displays the control operation as indicated by the text.
°F, °C	°F, °C Displays the unit of measure that all of the temperatures are to be displayed in the control.		

## Sequence of Operation

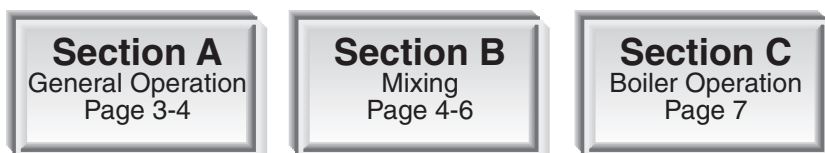

## Section A — General Operation

### POWERING UP THE CONTROL

When the Mixing Control 356 is powered up, the control displays the control type number in the LCD for 2 seconds. Next, the software version is displayed for 2 seconds. Finally, the control enters into the normal operating mode and the LCD defaults to displaying the current outdoor air temperature.

## OPERATION

The 356 uses a variable speed injection pump to control the supply water temperature to a hydronic system. The supply water temperature is based on either the current outdoor temperature, or a fixed setpoint.

### Outdoor Reset

When the outdoor design (OUTDR DSGN) setting is not set to OFF, the 356 calculates a mixing supply temperature based on the current outdoor air temperature and the *Characterized Heating Curve* settings.

### Setpoint Control

When the outdoor design (OUTDR DSGN) setting is set to OFF, the 356 supplies a fixed mixing supply temperature equal to the MIX TARGET setting. An outdoor sensor is not required during this mode of operation.

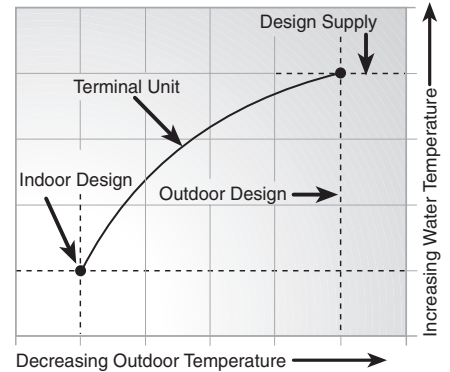

## VARIABLE SPEED INJECTION

A standard wet rotor circulator is connected to the 356 at the back of the control. The 356 increases or decreases the power output to the circulator when there is a mixing demand. The circulator speed varies to maintain the correct mixed supply water temperature at the mix sensor. For correct sizing and piping of the variable speed injection driven circulator, refer to essay E 021. A visual indication of the current variable speed output is displayed in the LCD in the form of a horizontal bar graph.

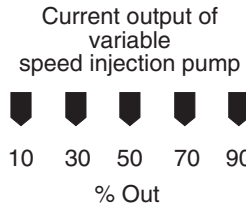

## BOILER PROTECTION (BOIL MIN)

The 356 is capable of providing boiler protection from cold mixing system return water temperatures. If the boiler sensor temperature is cooler than the BOIL MIN setting while the boiler is firing, the 356 reduces the output to the variable speed injection pump. This limits the amount of cool return water to the boiler, and allows the boiler temperature to recover. This feature can only be used if a boiler sensor is installed.

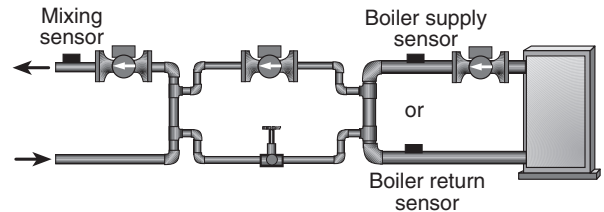

## EXERCISING

The 356 has a built-in exercising function. If the pump has not been operated at least once every 3 days, the control turns on the output for 10 seconds. This minimizes the possibility of the pump seizing during a long period of inactivity.

**Note:** The exercising function does not work if power to the control or pump is disconnected.

## FACTORY DEFAULTS

The control comes preset with several factory defaults. These defaults are based on the terminal unit selection (see section B2). To fine-tune building requirements, these defaults may be changed. If a factory default value for a terminal unit is changed, the terminal unit number will flash when selected in the ADJUST menu.

To reload the factory defaults listed in section B2, power down the control and wait for 10 seconds. Power up the control while simultaneously holding the *Item* and *▼* buttons. The terminal unit number should now be displayed constantly in the LCD rather than flashing.

## Section B: Mixing

**Section B1**  
General

**Section B2**  
Installer

**Section B3**  
Advanced

## Section B1: General

### MIXING DEMAND

A mixing demand is required in order for the 356 to provide heat. A mixing demand is generated by connecting terminal T(7) to terminal C-(9) through a switching device. Once the switching device closes, the *Mixing Demand* pointer is displayed in the LCD. The 356 calculates a MIX TARGET supply temperature based on the outdoor air temperature and settings. If required, the 356 operates the boiler in order to provide heat to the variable speed injection pump.

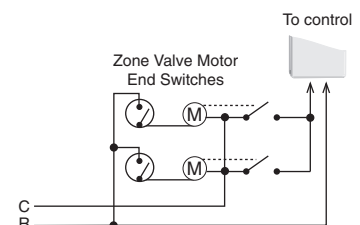

## CHARACTERIZED HEATING CURVE

When used as a mixing reset control, the 356 varies the supply water temperature based on the outdoor air temperature. The control takes into account the type of terminal unit that the system is using. Since different types of terminal units transfer heat to a space using different proportions of radiation, convection and conduction, the supply water temperature must be controlled differently. Once the control is told what type of terminal unit is used, the control loads the factory defaults and varies the supply water temperature according to the type of terminal unit. This improves the control of the air temperature in the building.

## MIXING TARGET TEMPERATURE (MIX TARGET)

When used as a mixing reset control, the MIX TARGET temperature is determined from the *Characterized Heating Curve* settings and outdoor air temperature. When used as a setpoint control, the installer will set the MIX TARGET temperature. The control displays the temperature that it is currently trying to maintain as the mixing supply temperature. If the control does not have a mixing demand, “- - -” is displayed as the MIX TARGET.

## Section B2: Installer

### OUTDOOR DESIGN (OUTDR DSGN)

The OUTDR DSGN is the outdoor air temperature that is the typical coldest temperature of the year where the building is located. This temperature is used when doing the heat loss calculations for the building. If a cold outdoor design temperature is selected, the mixing supply temperature rises gradually as the outdoor temperature drops. If a warm outdoor design temperature is selected, the mixing supply temperature rises rapidly as the outdoor temperature drops.

### SETPOINT OPERATION (MIX TARGET)

For setpoint operation, set the OUTDR DSGN to OFF. The MIX TARGET becomes the setpoint supply temperature that the control is to maintain. The MIX TARGET temperature is set by the installer in the ADJUST menu. An outdoor sensor is not required during this mode of operation.

### ROOM (ROOM)

The ROOM is the desired room temperature for the mixing zones, and it provides a parallel shift of the *Characterized Heating Curve*. The room temperature desired by the occupants is often different from the design indoor temperature (MIX INDR). If the room temperature is not correct, adjusting the ROOM setting increases or decreases the amount of heat available to the building.

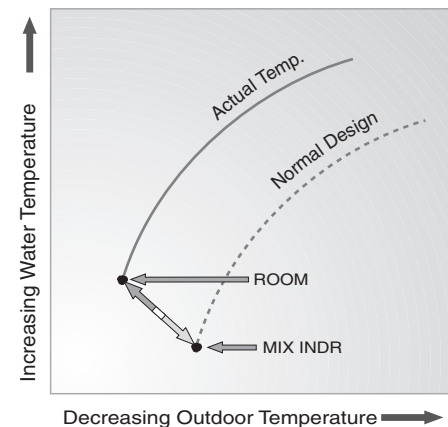
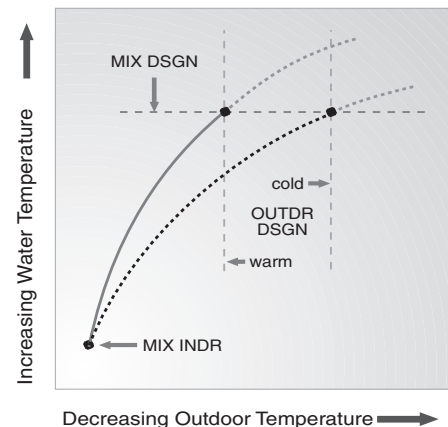

## TERMINAL UNITS

When using a *Characterized Heating Curve*, the control requires the selection of a terminal unit. The terminal unit determines the shape of the *Characterized Heating Curve* according to how the terminal unit delivers heat into the building space (refer to Essay E 003). The 356 provides for selection between six different terminal unit types: two types of radiant floor heat, fancoil, fin-tube convactor, radiator and baseboard. When a terminal unit is selected, the control automatically loads the design supply temperature (MIX DSGN) and maximum supply temperature (MIX MAX). The factory defaults are listed below. To change defaults, refer to section B3. If a default has been changed, refer to section A to reload the factory defaults.

Terminal Unit	High Mass Radiant (1)	Low Mass Radiant (2)	Fancoil (3)	Fin-tube Convactor (4)	Radiator (5)	Baseboard (6)
MIX DSGN	120°F (49°C)	140°F (60°C)	190°F (88°C)	180°F (82°C)	160°F (71°C)	150°F (66°C)
MIX MAX	140°F (60°C)	160°F (71°C)	210°F (99°C)	200°F (93°C)	180°F (82°C)	170°F (77°C)

### High Mass Radiant (1)

This type of a hydronic radiant floor is embedded in either a thick concrete or gypsum pour. This heating system has a large thermal mass and is slow acting.  
Default values: MIX DSGN = 120°F (49°C), MIX MAX = 140°F (60°C)

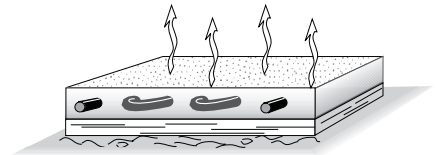

### Low Mass Radiant (2)

This type of radiant heating system is either attached to the bottom of a wood sub-floor, suspended in the joist space, or sandwiched between the sub-floor and the surface. This type of radiant system has a relatively low thermal mass and responds faster than a high mass system.  
Default values: MIX DSGN = 140°F (60°C), MIX MAX = 160°F (71°C)

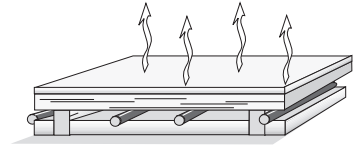

### Fancoil (3)

A fancoil terminal unit or air handling unit (AHU) consists of a hydronic heating coil and either a fan or blower. Air is forced across the coil at a constant velocity by the fan or blower, and is then delivered into the building space.  
Default values: MIX DSGN = 190°F (88°C), MIX MAX = 210°F (99°C)

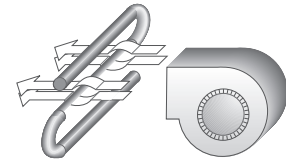

### Fin-tube Convectector (4)

A convectector terminal unit is made up of a heating element with fins on it. This type of terminal unit relies on the natural convection of air across the heating element to deliver heated air into the space. The amount of natural convection to the space is dependant on the supply water temperature to the heating element and the room air temperature.  
Default values: MIX DSGN = 180°F (82°C), MIX MAX = 200°F (93°C)

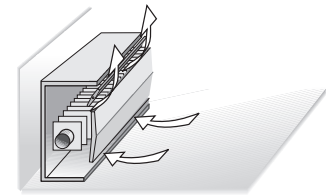

### Radiator (5)

A radiator terminal unit has a large heated surface that is exposed to the room. A radiator provides heat to the room through radiant heat transfer and natural convection.  
Default values: MIX DSGN = 160°F (71°C), MIX MAX = 180°F (82°C)

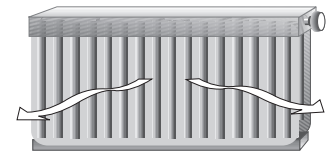

### Baseboard (6)

A baseboard terminal unit is similar to a radiator, but has a low profile and is installed at the base of the wall. The proportion of heat transferred by radiation from a baseboard is greater than that from a fin-tube convectector.  
Default values: MIX DSGN = 150°F (66°C), MIX MAX = 170°F (77°C)



## Section B3: Advanced

### MIXING INDOOR (MIX INDR)

The MIX INDR is the room temperature used in the original heat loss calculations for the building. This setting establishes the beginning of the *Characterized Heating Curve* for the mixing zones.

### MIXING DESIGN (MIX DSGN)

The MIX DSGN temperature is the supply water temperature required to heat the mixing zones when the outdoor air is as cold as the OUTDR DSGN temperature.

### MIXING MAXIMUM (MIX MAX)

The MIX MAX sets the highest water temperature that the control is allowed to calculate as the MIX TARGET temperature. If the control does target the MIX MAX setting, and the MIX temperature is near the MIX MAX, the MAX segment will be displayed in the LCD while either the MIX TARGET temperature or the MIX temperature is being viewed.

### WARM WEATHER SHUT DOWN (WWSD)

When the outdoor air temperature rises above the WWSD setting, the 356 turns on the WWSD segment in the display. When the control is in Warm Weather Shut Down, the *Mixing Demand* pointer is displayed, if there is a demand. However, the control does not operate the heating system to satisfy this demand. If the control is in setpoint mode, the WWSD feature is not functional.

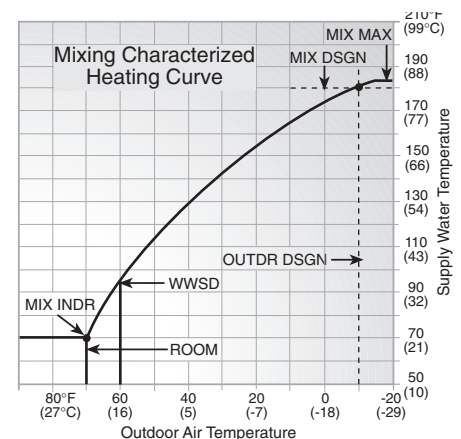

## Section C: Boiler Operation

**Section C1**  
General Operation

**Section C2**  
Boiler Sensor  
Placement

### Section C1: General Operation

#### BOILER OPERATION

When the 356 determines that boiler operation is required, the *Boiler* contact terminals (5 and 6) close. While the *Boiler* contact is closed, the burner segment in the LCD is displayed.

#### BOILER MINIMUM (BOIL MIN)

Most boilers require a minimum water temperature in order to prevent flue gas condensation. The BOIL MIN adjustment is set to the boiler manufacturer's minimum recommended operating temperature. Only when the boiler temperature is measured by a boiler sensor can the 356 provide boiler protection. In this case, when the boiler is firing and the boiler temperature is below the BOIL MIN setting, the 356 turns on the MIN segment and reduces the heating load on the boiler by limiting the output of the variable speed injection pump. If the installed boiler is designed for low temperature operation, set the BOIL MIN adjustment to OFF.

#### BOILER PROTECTION

Refer to section A for a description of boiler protection.

### Section C2: Boiler Sensor Placement

#### BOILER SENSOR ON THE SUPPLY (BOIL = *Supply*)

The boiler sensor can be located on the boiler supply if the 356 is the only control that is operating the boiler. When in the supply mode, the 356 determines the required operating temperature of the boiler using *Boiler Load Reset*. With *Boiler Load Reset*, the 356 operates the boiler at the lowest possible supply temperature that is sufficient to satisfy the requirements of the variable speed injection pump. If this mode of operation is selected, the boiler pump should operate continuously.

**Note:** The boiler pump should not be operated by the boiler's aquastat, as this may lead to improper cycling of the boiler because of inconsistent flow past the boiler supply sensor.

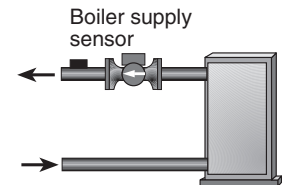

#### BOILER SENSOR ON THE RETURN (BOIL = *Return*)

The boiler sensor should be located on the boiler return if the 356 is one of many controls that can call for boiler operation. When in the return mode, the 356 provides a boiler enable. The 356 no longer tries to control the boiler supply water temperature directly, but allows the boiler to operate at its operating aquastat setting when required. If this mode of operation is selected, the boiler pump should operate continuously.

**Note:** The boiler pump should not be operated by the boiler's aquastat, as this may lead to improper cycling of the boiler because of inconsistent flow past the boiler return sensor.

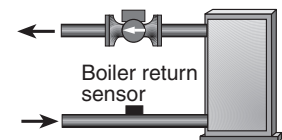

#### NO BOILER SENSOR

The 356 is capable of operating without a boiler sensor if desired. Without a boiler sensor the 356 provides a boiler enable, and is unable to provide boiler protection. This type of application is typical if the 356 is drawing heat from a heat source that already incorporates some form of boiler protection.

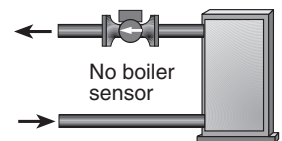

## Installation

### CAUTION

Improper installation and operation of this control could result in damage to the equipment and possibly even personal injury. It is your responsibility to ensure that this control is safely installed according to all applicable codes and standards. This electronic control is not intended for use as a primary limit control. Other controls that are intended and certified as safety limits must be placed into the control circuit.

### STEP ONE — GETTING READY

Check the contents of this package. If any of the contents listed are missing or damaged, please contact your wholesaler or tekmar sales representative for assistance.

Type 356 includes: One Mixing Control 356, One Outdoor Sensor 070, Two Universal Sensors 071, Data Brochures D 356, D 070, D 001, Application Brochure A 356, Essay E 021.

**Note:** Carefully read the details of the *Sequence of Operation* to ensure that you have chosen the proper control for your application.

### STEP TWO — MOUNTING

The control is mounted in accordance with the instructions in the Data Brochure D 001.

### STEP THREE — ROUGH-IN WIRING

The variable speed injection pump wiring terminates in the electrical box. All other wiring terminates in the two wiring chambers on the control. Determine whether the low voltage wiring enters the wiring chamber through the back or the bottom of the control. The wiring is roughed-in to the electrical box prior to installation of the control (see Brochure D 001). Standard 18 AWG solid wire is recommended for all low voltage wiring, and multi-strand 16 AWG wire is recommended for 120 V (ac) wiring.

**Power must not be applied to any of the wires during the rough-in wiring stage.**

- Install the Outdoor Sensor 070, Boiler Sensor 071, and Mixing Sensor 071 according to the instructions in the Data Brochure D 070, and run the wiring back to the control.
- Run wire from the boiler to the control.
- Run wires from the 24 V (ac) power to the control. Use a clean power source to ensure proper operation.

### STEP FOUR — TESTING THE WIRING

**No wires should be connected to the control during testing.**

The following tests are to be performed using standard testing practices and procedures, and should only be carried out by properly trained and experienced persons.

A good quality electrical test meter, capable of reading from at least 0 - 300 V (ac) and at least 0 - 2,000,000 Ohms, is essential to properly test the wiring and sensors.

#### Test The Sensors

Ensure the sensor wires are not connected to the control terminals before testing. In order to test the sensors, the actual temperature at each sensor location must be measured. A good quality digital thermometer with a surface temperature probe is recommended for ease of use and accuracy. Where a digital thermometer is not available, a spare sensor can be strapped alongside the one to be tested, and the readings compared. Test the sensors according to the instructions in the Data Brochure D 070.

#### Test The Power Supply

Make sure exposed wires and bare terminals are not in contact with other wires or grounded surfaces. Turn on the power and measure the voltage across the 24 V (ac) power supply with an AC voltmeter. The reading should be between 22 and 26 V (ac).

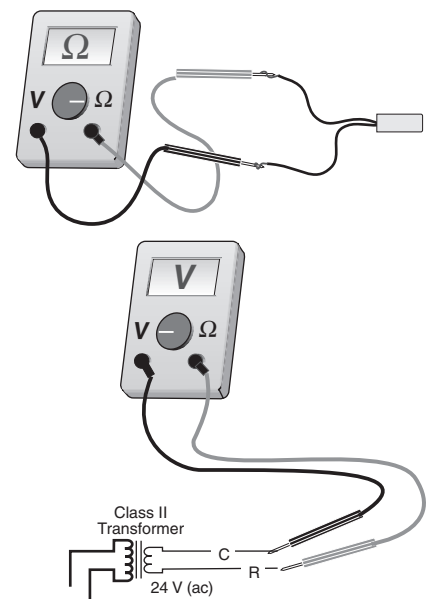



## Test The Powered Inputs

### Mixing Demand

Measure the voltage between the mixing demand wire and the power wire that goes to R+ of the control. The voltmeter should read between 22 and 26 V (ac) when the mixing demand device calls for heat.

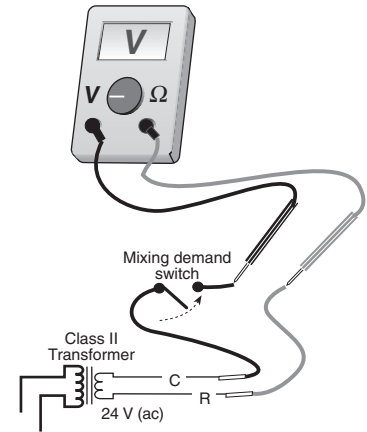

## Test The Outputs

### Boiler

Make sure power to the boiler circuit is off and short the boiler wires. When the boiler circuit is powered up, the boiler should fire. If the boiler does not turn on, refer to any installation or troubleshooting information supplied with the boiler. (The boiler may have a flow switch that prevents firing until the boiler loop pump is running). If the boiler operates properly, remove power from the boiler circuit.

### Variable Speed Injection Pump

Short the variable speed injection pump wires and power up the pump circuit; the variable speed pump should operate at full speed. If the pump does not operate, check the wiring, and refer to any installation or troubleshooting information supplied with the boiler. If the pump operates properly, remove the power from the variable speed injection pump circuit.

## STEP FIVE — ELECTRICAL CONNECTIONS TO THE CONTROL

The installer should test to confirm that no voltage is present at any of the wires.

### Powered Input Connections

#### 24 V (ac) Power

Connect the 24 V (ac) power supply to the *Power R+* and *Power C-* terminals (8 and 9). This connection provides power to the microprocessor and display of the control.

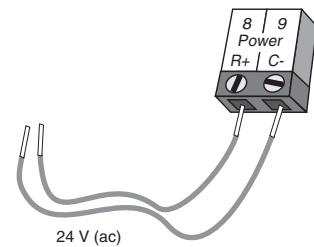

#### Mixing Demand

To generate a mixing demand, terminal *T(7)* must be connected to terminal *C-(9)* through a switching device.

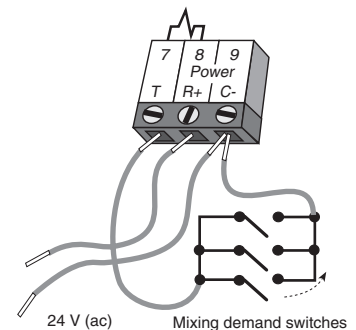

## Output Connections

### Boiler Contact

The *Boiler* terminals (5 and 6) are an isolated output in the 356. There is no power available on these terminals from the control. These terminals are to be used as a switch to either make or break the boiler circuit. When the 356 requires the boiler to fire, it closes the contact between terminals 5 and 6.

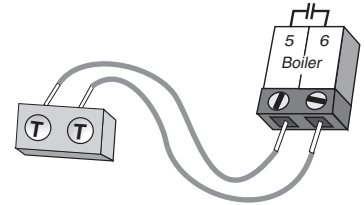

### Variable Speed Injection Pump

The 356 can vary the speed of a permanent capacitor, impedance protected, or equivalent pump motor that has a locked rotor current of less than 2.4 A. Most small wet rotor circulators are suitable as described in Essay E 021. The 356 has an internal overload protection circuit which is rated at 2.5 A 250 V (ac). Contact your tekmar sales representative for details on the repair procedures if this circuit is blown.

Connect one of the wires from the variable speed injection pump to one of the black wires from the back of the control. Connect the second black wire from the back to the live (L) side of the 120 V (ac) power source. The other wire on the variable speed injection pump must be connected to the neutral (N) side of the 120 V (ac) power supply. Connect the green wire on the back of the control to ground.

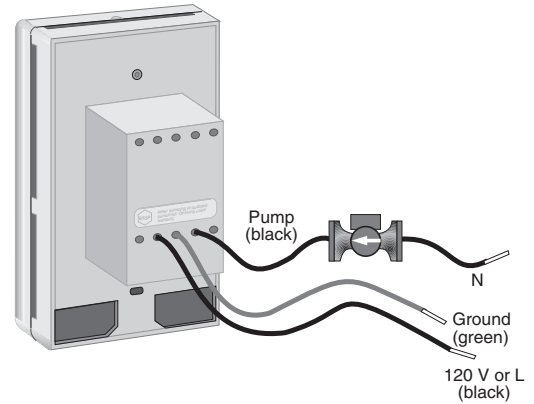

## Sensor and Unpowered Input Connections

**Do not apply power to these terminals as this will damage the control.**

### Outdoor Sensor

Connect the two wires from the Outdoor Sensor 070 to the *Com* and *Out* terminals (1 and 3). The outdoor sensor is used by the 356 to measure the outdoor air temperature.

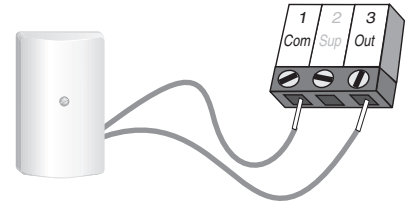

### Boiler Sensor

Connect the two wires from the Boiler Sensor 071 to the *Com* and *Boil* terminals (1 and 4). The boiler sensor is used by the 356 to measure the boiler temperature.

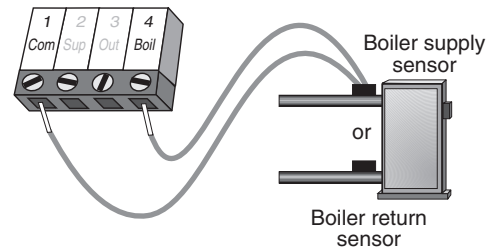

### Mixing Sensor

Connect the two wires from the Mixing Sensor 071 to the *Com* and *Sup* terminals (1 and 2). The mixing sensor is used by the 356 to measure the supply water temperature after the variable speed injection pump. Normally the sensor is attached to the pipe downstream of the system pump.

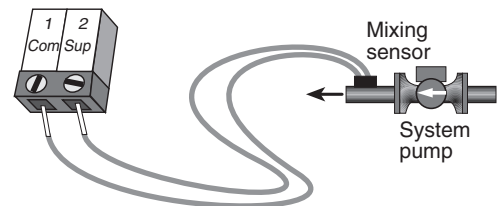

## DIP Switch Setting

### ADVANCED / INSTALLER

The *Advanced / Installer* DIP switch is used to select which items are available to be viewed and / or adjusted in the user interface.

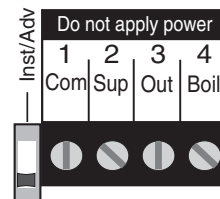

## Quick Setup

The quick setup can be used for both outdoor reset and setpoint operation. To enter the installer programming mode, set the *Advanced / Installer* DIP switch to *Installer*.

### OUTDOOR RESET

Access the ADJUST menu by pressing and holding simultaneously for 1 second, the **Item**, ▲ and ▼ buttons. The display will now show the word ADJUST in the top right corner.



The ROOM adjustment is the first item displayed. Use the ▲ or ▼ button to set the ROOM temperature. The ROOM setting is set to the desired room air temperature.

**Note:** To increase or decrease space temperature, only adjust the ROOM setting.



Press and release the **Item** button to advance to the OUTDR DSGN adjustment. Use the ▲ or ▼ button to set the outdoor design temperature. The OUTDR DSGN setting is set to the typical coldest temperature of the year.

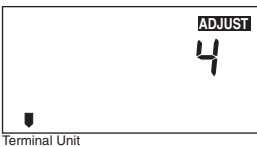

Press and release the **Item** button to advance to the *Terminal Unit* adjustment. Use the ▲ or ▼ button to select the desired terminal unit. The terminal unit number corresponds to the type of terminal that is being used. The table below lists the terminal units and their default values.

Terminal Unit	High Mass Radiant (1)	Low Mass Radiant (2)	Fancoil (3)	Fin-tube Convector (4)	Radiator (5)	Baseboard (6)
MIX DSGN	120°F (49°C)	140°F (60°C)	190°F (88°C)	180°F (82°C)	160°F (71°C)	150°F (66°C)
MIX MAX	140°F (60°C)	160°F (71°C)	210°F (99°C)	200°F (93°C)	180°F (82°C)	170°F (77°C)



Press and release the **Item** button to advance to the units adjustment. Use the ▲ or ▼ button to set the scale to °F or °C.

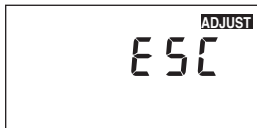

To exit the ADJUST menu, press and release the **Item** button to advance to the ESC item. Then either press the ▲ or ▼ button, or leave the buttons alone for 20 seconds.

### SETPOINT CONTROL

Access the ADJUST menu by pressing and holding simultaneously for 1 second, the **Item**, ▲ and ▼ buttons. The display will now show the word ADJUST in the top right corner.



Press and release the **Item** button to advance to the OUTDR DSGN adjustment. Press and hold the ▲ button until OFF is displayed.



Press and release the **Item** button to advance to the MIX TARGET adjustment. Use the ▲ or ▼ button to select the desired temperature. The MIX TARGET setting is set to the desired setpoint supply temperature.

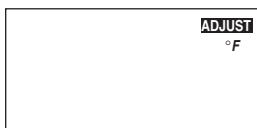

Press and release the **Item** button to advance to the units adjustment. Use the ▲ or ▼ button to set the scale to °F or °C.

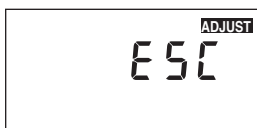

To exit the ADJUST menu, press and release the **Item** button to advance to the ESC item. Then either press the ▲ or ▼ button, or leave the buttons alone for 20 seconds..





## View Menu (1 of 1)

Display	Section Installer Advanced			Description	Range
	Section	Installer	Advanced		
		<input type="radio"/>	<input checked="" type="radio"/>	Current outdoor air temperature as measured by the outdoor sensor. This is also the default display for the control. <b>(OUTDR DSGN ≠ OFF)</b>	-67 to 149°F (-55 to 65°C)
	B3	<input type="radio"/>	<input checked="" type="radio"/>	Current mixed supply water temperature as measured by the mixing sensor.	14 to 266°F (-10 to 130°C)
	B1 B2 B3	<input type="radio"/>	<input checked="" type="radio"/>	Target mixed supply is the temperature the control is currently trying to maintain at the mixing sensor.	---, 14 to 266°F (---, -10 to 130°C)
		<input type="radio"/>	<input checked="" type="radio"/>	Current boiler temperature as measured by the boiler sensor. <b>(Boiler sensor is present)</b>	14 to 266°F (-10 to 130°C)

## Adjust Menu (1 of 2)

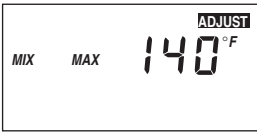
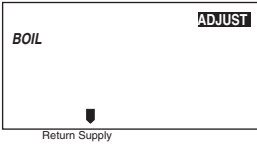
Display	Section Installer Advanced			Description	Range	Actual Setting
	Section	Installer	Advanced			
	B2	<input type="radio"/>	<input checked="" type="radio"/>	The desired room air temperature. <b>(OUTDR DSGN ≠ OFF)</b>	35 to 100°F (2 to 38°C)	
	B2	<input type="radio"/>	<input checked="" type="radio"/>	Mixing setpoint temperature. <b>(OUTDR DSGN = OFF)</b>	OFF, 60 to 200°F (OFF, 16 to 93°C)	
	B2	<input type="radio"/>	<input checked="" type="radio"/>	The design outdoor air temperature used in the heat loss calculation for the heating system. For setpoint operation, set the OUTDR DSGN to OFF.	-60 to 32°F, OFF (51 to 0°C, OFF)	
	B2	<input type="radio"/>	<input checked="" type="radio"/>	The type of terminal units that are being used in the heating system. <b>(OUTDR DSGN ≠ OFF)</b>	1 (High Mass Radiant), 2 (Low Mass Radiant), 3 (Fancoil), 4 (Fin-tube Convectector), 5 (Radiator), 6 (Baseboard)	
	B3		<input checked="" type="radio"/>	The design indoor air temperature used in the heat loss calculation for the heating system. <b>(OUTDR DSGN ≠ OFF)</b>	35 to 100°F (2 to 38°C)	
	B3		<input checked="" type="radio"/>	The design supply water temperature used in the heat loss calculation for the heating system. <b>(OUTDR DSGN ≠ OFF)</b>	70 to 220°F (21 to 104°C)	

## Adjust Menu (2 of 2)

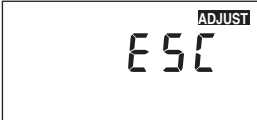
Display	Section			Description	Range	Actual Setting
	Installer	Advanced				
	B3		●	The maximum supply temperature for the mixing system. <b>(OUTDR DSGN ≠ OFF)</b>	80 to 225°F (27 to 107°C)	
	C2		●	The location of the boiler sensor. This effects operation of the boiler contact. <b>(Boiler sensor is present)</b>	Return, Supply	
	C1		●	The minimum temperature allowed for the boiler target temperature. <b>(Boiler sensor is present)</b>	OFF, 80 to 180°F (OFF, 27 to 82°C)	
	B3		●	The system's warm weather shut down.	35 to 100°F, OFF (2 to 38°C, OFF)	
		●	●	The units of measure that all of the temperatures are to be displayed in the control.	°F, °C	
		●	●	This item exits the ADJUST menu by pressing either the ▲ or ▼ button.		

## Testing the Control

The Mixing Control 356 has a built-in test routine which is used to test the main control functions. The 356 continually monitors the sensors and displays an error message whenever a fault is found. See the following pages for a list of the 356's error messages and possible causes. When the ▲ button is pressed, the *Boiler* relay closes and the variable speed injection pump turns on to 100% of its output speed. Once the ▲ button is released, the output relays return to normal operation.

## Troubleshooting

When troubleshooting any heating system, it is always a good idea to establish a set routine to follow. By following a consistent routine, many hours of potential headaches can be avoided. Below is an example of a sequence that can be used when diagnosing or troubleshooting problems in a hydronic heating system.

### Establish the Problem

Establish the problem. Get as much information from the customer as possible about the problem. Is there too much heat, not enough heat, or no heat? Is the problem only in one particular zone or area of the building, or does the problem affect the entire system? Is this a consistent problem or only intermittent? How long has the problem existed for? This information is critical in correctly diagnosing the problem.

### Understand the Sequence of Operation

Understand the sequence of operation of the system. If a particular zone is not receiving enough heat, which pumps or valves in the system must operate in order to deliver heat to the affected zone? If the zone is receiving too much heat, which pumps, valves, or check valves must operate in order to stop the delivery of heat?

### Sketch the Piping in the System

Sketch the piping of the system. This is a relatively simple step that tends to be overlooked, however, it can often save hours of time in troubleshooting a system. Note flow directions in the system paying close attention to the location of pumps, check valves, pressure bypass valves, and mixing valves. Ensure correct flow direction on all pumps. This is also a very useful step if additional assistance is required.

### Document the Control

Document the control for future reference. Before making any adjustments to the control, note down all of the items that the control is currently displaying. This includes items such as error messages, current temperatures and settings, and which devices should be operating as indicated by the LCD. This information is an essential step if additional assistance is required to diagnose the problem.

### Isolate the Problem

Isolate the problem between the control and the system. Now that the sequence of operation is known and the system is sketched, is the control operating the proper pumps and valves at the correct times? Is the control receiving the correct signals from the system as to when it should be operating? Are the proper items selected in the menus of the control for the device that is to be operated?

### Test the Contacts Voltages & Sensors

Test the contacts, voltages and sensors. Using a multimeter, ensure that the control is receiving adequate voltage to the power terminals and the demand terminals as noted in the technical data. Use the multimeter to determine if the internal contacts on the control are opening and closing correctly. Follow the instructions in the Testing the Wiring section to simulate closed contacts on the terminal blocks as required. Test the sensors and their wiring as described in the sensor Data Brochures.

## Error Messages



The control was unable to read a piece of information from its EEPROM. This error can be caused by a noisy power source. The control will load the factory defaults and stop operation until all the settings are verified.



The control is no longer able to read the outdoor sensor due to a short circuit. In this case the control assumes an outdoor temperature of 32°F (0°C) and continues operation. Locate and repair the problem as described in the Data Brochure D 070. To clear the error message from the control after the sensor has been repaired, press the **Item** button.

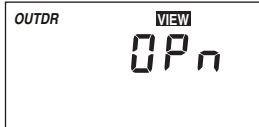

The control is no longer able to read the outdoor sensor due to an open circuit. In this case the control assumes an outdoor temperature of 32°F (0°C) and continues operation. Locate and repair the problem as described in the Data Brochure D 070. To clear the error message from the control after the sensor has been repaired, press the **Item** button.

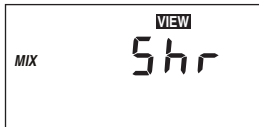

The control is no longer able to read the mixing supply sensor due to a short circuit. In this case the control will operate the injection pump at a fixed output as long as there is a mixing demand. Locate and repair the problem as described in the Data Brochure D 070. To clear the error message from the control after the sensor has been repaired, press the **Item** button.

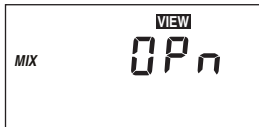

The control is no longer able to read the mixing supply sensor due to an open circuit. In this case the control will operate the injection pump at a fixed output as long as there is a mixing demand. Locate and repair the problem as described in the Data Brochure D 070. To clear the error message from the control after the sensor has been repaired, press the **Item** button.

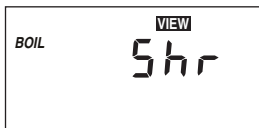

The control is no longer able to read the boiler sensor due to a short circuit. If the BOIL MIN adjustment is higher than 100°F (38°C), the control closes the *Boiler* contact when the injection pump starts to operate. The boiler temperature is limited by the operating aquastat. If the BOIL MIN adjustment is lower than 100°F (38°C), the control does not operate the *Boiler* contact. Locate and repair the problem as described in the Data Brochure D 070. To clear the error message from the control after the sensor has been repaired, press the **Item** button.

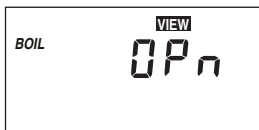

The control is no longer able to read the boiler sensor due to an open circuit. If the BOIL MIN adjustment is higher than 100°F (38°C), the control closes the *Boiler* contact when the injection pump starts to operate. The boiler temperature is limited by the operating aquastat. If the BOIL MIN adjustment is lower than 100°F (38°C), the control does not operate the *Boiler* contact. Locate and repair the problem as described in the Data Brochure D 070. If the boiler sensor is deliberately removed, the control must be powered down, and then powered back up. To clear the error message from the control after the sensor has been repaired, press the **Item** button.

