

tekmar® - Data Brochure

Mixing Control 361

D 361

03/09

The Mixing Control 361 is designed to control the supply water temperature to a hydronic system in order to provide outdoor reset or setpoint operation. The control uses a variable speed injection pump to regulate the supply water temperature, while protecting the boiler against flue gas condensation. The control has a Liquid Crystal Display (LCD) to view system status and operating information.

Additional functions include:

- Quick Setup for easy installation and programming of control
- User comfort adjustment to increase or decrease building space temperature
- Advanced settings to fine-tune building requirements
- Boiler Control for improved energy savings
- Powered mixing system pump output
- Optional indoor sensor for room air temperature control
- Test sequence to ensure proper component operation
- Setback input for energy savings
- 120 V (ac) power supply
- CSA C US certified (approved to applicable UL standards)

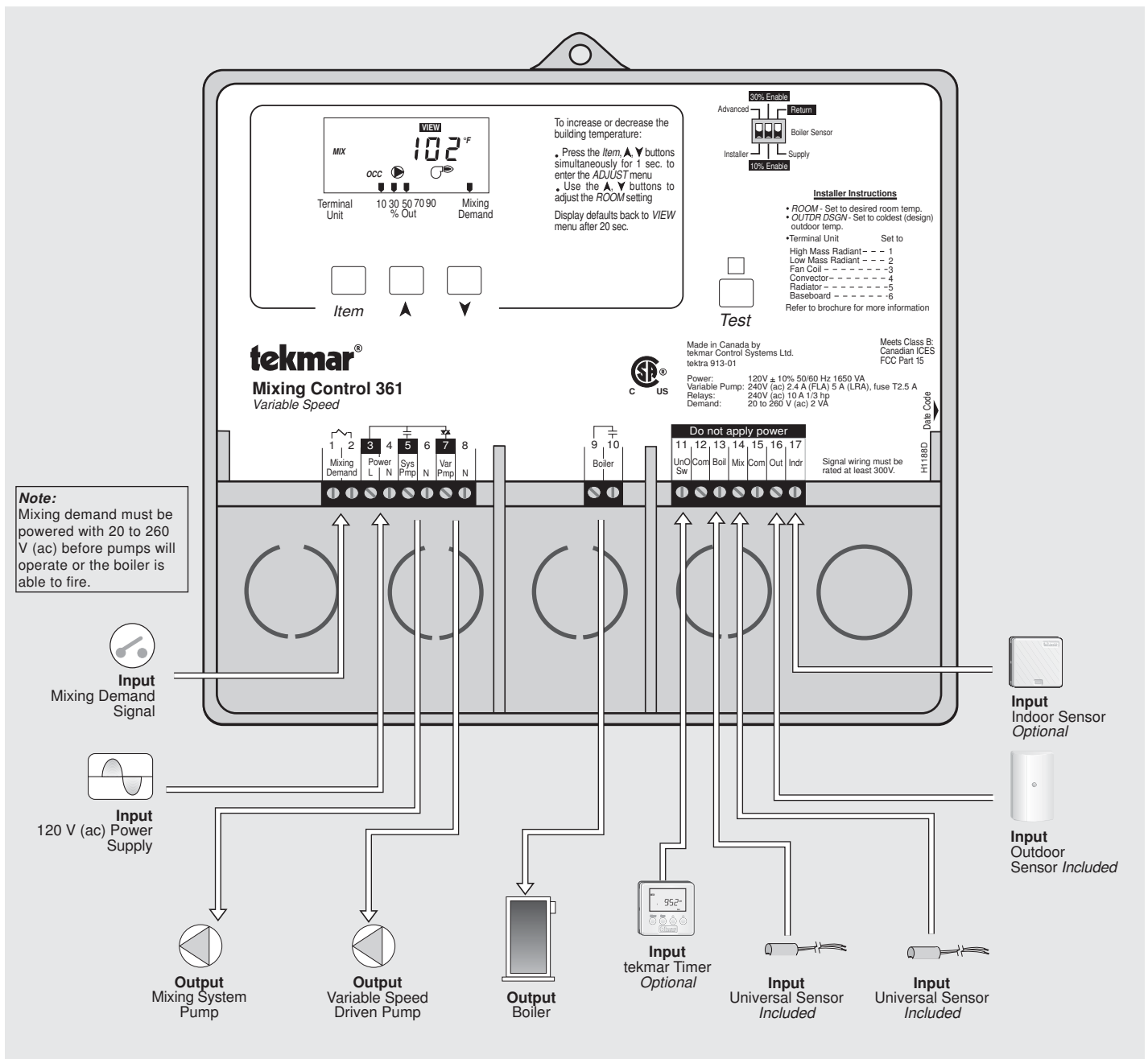

How To Use The Data Brochure

This brochure is organized into four main sections. They are: 1) *Sequence of Operation*, 2) *Installation*, 3) *Control Settings*, and 4) *Troubleshooting*. The *Sequence of Operation* section has three sub-sections. We recommend reading *Section A: General Operation* of the *Sequence of Operation*, as this contains important information on the overall operation of the control. Then read the sub-sections that apply to your installation. For quick installation and setup of the control, refer to the *Installation* section, *DIP Switch Settings* section, followed by the *Quick Setup* section.

The *Control Settings* section (starting at *DIP Switch Settings*) of this brochure, describes the various items that are adjusted and displayed by the control. The control functions of each adjustable item are described in the *Sequence of Operation*.

Table of Contents

User Interface	pg 2	Quick Setup	pg 14
Description of Display Elements	pg 3	Control Settings	pg 15
Sequence of Operation	pg 4	View Menu	pg 15
Section A: General Operation	pg 4	Adjust Menu	pg 16
Section B: Mixing	pg 5	Testing and Troubleshooting	pg 17
Section C: Boiler Operation	pg 8	Error Messages	pg 19
Installation	pg 10	Technical Data	pg 20
DIP Switch Settings	pg 14	Limited Warranty	pg 20

Reference Material: Essay E 003 "Characterized Heating Curve and Reset Ratio"
Essay E 021 "Mixing Methods and Sizing of Variable Speed Injection Pumps"

User Interface

The 361 uses a Liquid Crystal Display (LCD) as the method of supplying information. You use the LCD in order to set up and monitor the operation of your system. The 361 has three push buttons (*Item*, ▲, ▼) for selecting, viewing, and adjusting settings. As you program your control, record your settings in the ADJUST menu table which is found in the second half of this brochure.

Item

The abbreviated name of the selected item will be displayed in the item field of the display. To view the next available item, press and release the *Item* button. Once you have reached the last available item, pressing and releasing the *Item* button will return the display to the first item.



Adjust

To make an adjustment to a setting in the control, press and hold simultaneously for 1 second, all three buttons. The display will then show the word ADJUST in the top right corner. Then select the desired item using the *Item* button. Finally, use the ▲ and / or ▼ button to make the adjustment.

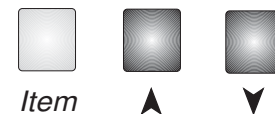

To exit the ADJUST menu, either select the ESC item and press the ▲ or ▼ button, or leave the adjustment buttons alone for 20 seconds.

When the *Item* button is pressed and held in the VIEW menu, the display scrolls through all the adjust items in both access levels.

Additional information can be gained by observing the status field and pointers of the LCD. The status field will indicate which of the control's outputs are currently active. Most symbols in the status field are only visible when the VIEW menu is selected.

Display

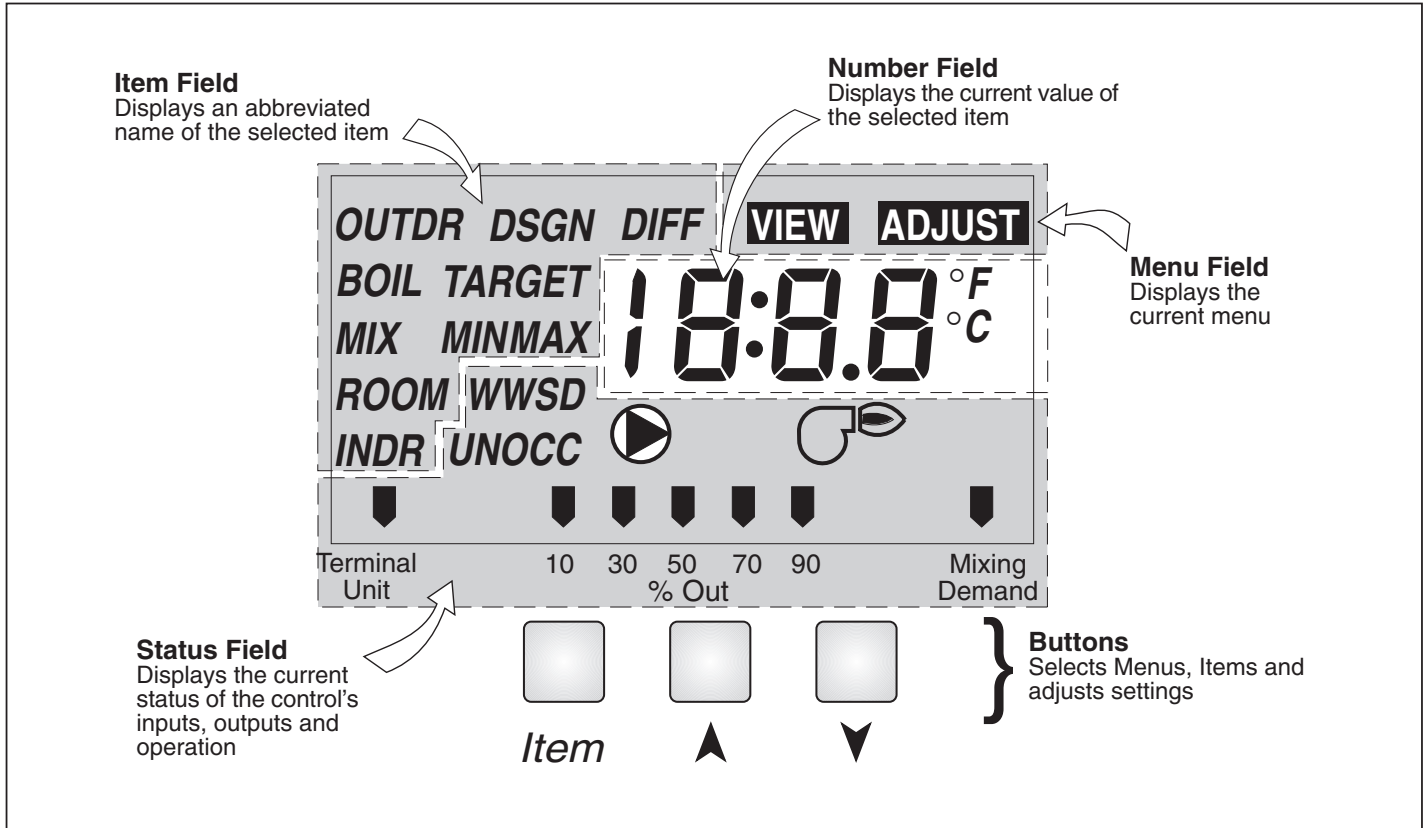

Symbol Description

	Pump Displays when the mixing system pump is in operation.	<i>UNOCC</i>	Unoccupied Schedule Displays when the control is in unoccupied (Night) mode.
	Burner Displays when the boiler relay is turned on.	<i>°F, °C</i>	°F, °C Displays the unit of measure that all of the temperatures are to be displayed in the control.
<i>OCC</i>	Occupied Schedule Displays when the control is in occupied (Day) mode.		Pointer Displays the control operation as indicated by the text.

Sequence of Operation

Section A
General Operation
Page 4-5

Section B
Mixing
Page 5-8

Section C
Boiler Operation
Page 8-9

Section A —General Operation

POWERING UP THE CONTROL

When the Mixing Control 361 is powered up, the control displays the control type number in the LCD for 2 seconds. Next, the software version is displayed for 2 seconds. Finally, the control enters into the normal operating mode.

OPERATION

The 361 uses a variable speed injection pump to control the supply water temperature to a hydronic system. The supply water temperature is based on either the current outdoor temperature, or a fixed setpoint.

Outdoor Reset

When the outdoor design (OUTDR DSGN) setting is not set to OFF, the 361 calculates a mixing supply temperature based on the outdoor air temperature. The 361 uses a *Characterized Heating Curve* and optionally indoor temperature feedback from an indoor sensor in this calculation.

Setpoint Control

When the outdoor design (OUTDR DSGN) setting is set to OFF, the 361 supplies a fixed mixing supply temperature equal to the MIX TARGET setting. An outdoor sensor is not required during this mode of operation.

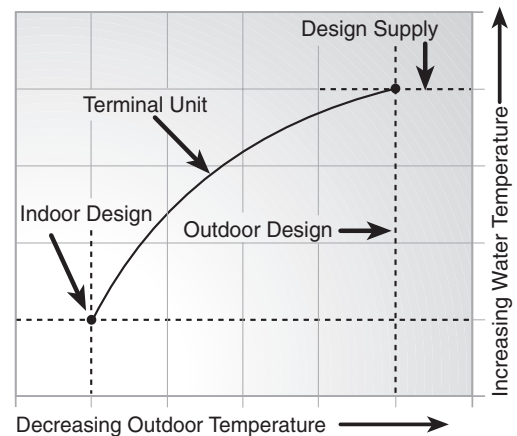

VARIABLE SPEED

A standard wet rotor circulator is connected to the 361 on the *Var Pmp* and *N* terminals (7 and 8). The 361 increases or decreases the power output to the circulator when there is a mixing demand. The circulator speed varies to maintain the correct mixed supply water temperature at the mix sensor. For correct sizing and piping of the variable speed driven circulator, refer to essay E 021. A visual indication of the current variable speed output is displayed in the LCD in the form of a horizontal bar graph.

Current output of variable speed injection pump



BOILER PROTECTION (BOIL MIN)

The 361 is capable of providing boiler protection from cold mixing system return water temperatures. If the boiler sensor temperature is cooler than the BOIL MIN setting while the boiler is firing, the 361 reduces the output to the variable speed injection pump. This limits the amount of cool return water to the boiler, and allows the boiler temperature to recover. This feature can only be used if a boiler sensor is installed.

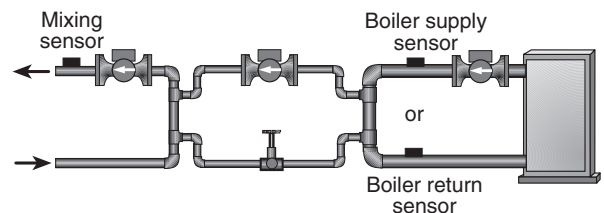

EXERCISING

The 361 has a built-in exercising function. If a pump has not been operated at least once every 3 days, the control turns on the output for 10 seconds. This minimizes the possibility of a pump seizing during a long period of inactivity. While the control is exercising, the *Test* LED flashes.

Note: The exercising function does not work if power to the control or pumps is disconnected.

SETBACK (UNOCCUPIED)

To provide greater energy savings, the 361 has a setback capability. With setback, the supply water temperature in the system is reduced when the building is unoccupied. By reducing the supply water temperature, air temperature in the space may be reduced even when thermostat(s) are not turned down. Any time the *UnO Sw* (11) and the *Com* (12) terminals are shorted together, the control operates in the unoccupied (Night) mode. When in the unoccupied (Night) mode, the UNOCC segment is displayed in the LCD. The 361 adjusts the supply water temperature based on the UNOCC settings made in the control. This feature has no effect when the control is used as a setpoint control.

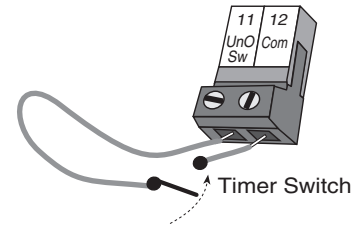

FACTORY DEFAULTS

The control comes preset with several factory defaults. These defaults are based on the terminal unit selection (see section B2). To fine-tune building requirements, these defaults may be changed. If a factory default value for a terminal unit is changed, the terminal unit number will flash when selected in the ADJUST menu.

To reload the factory defaults listed in section B2, power down the control and wait for 10 seconds. Power up the control while simultaneously holding the *Item* and ∇ buttons. The terminal unit number should now be displayed constantly in the LCD rather than flashing.

Section B: Mixing

Section B1
General

Section B2
Installer

Section B3
Advanced

Section B1: General

MIXING DEMAND

A mixing demand is required in order for the 361 to provide heat. A mixing demand is generated by applying a voltage between 24 and 240 V (ac) across the *Mixing Demand* terminals (1 and 2). Once voltage is applied, the *Mixing Demand* pointer is displayed in the LCD. If the 361 is not in WWSD, the 361 closes the *Sys Pmp* contact. The 361 calculates a MIX TARGET supply temperature based on the outdoor air temperature and settings. If required, the 361 operates the boiler in order to provide heat to the variable speed injection pump.

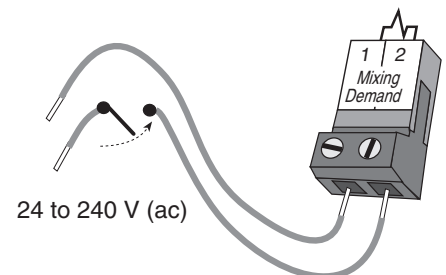

SYSTEM PUMP OPERATION (*Sys Pmp*)

The system pump contact (*Sys Pmp*, terminal 5) closes whenever there is a mixing demand and the 361 is not in WWSD. The system pump segment is displayed in the LCD. After the mixing demand has been satisfied, the 361 continues to operate the system pump for 20 seconds. This allows some residual heat to be purged out to the heating system. During WWSD, the system pump is operated based on the exercise function.

INDOOR SENSOR

An indoor sensor may be used in order to provide indoor temperature feedback. The indoor sensor is connected to the *Com* and *Inder* terminals (15 and 17). In addition, power must be applied to the *Mixing Demand* terminals (1 and 2) as described in the MIXING DEMAND section. With the indoor sensor connected, the 361 is able to sense the actual room temperature. Indoor temperature feedback fine-tunes the supply water temperature in the mixing system to maintain room temperature. To adjust the room temperature, use the ROOM OCC or ROOM UNOCC setting in the ADJUST menu at the control.

If a multiple zone system is used with an indoor sensor, proper placement of the indoor sensor is essential. The indoor sensor should be located in an area which best represents the average air temperature of the zones.

CHARACTERIZED HEATING CURVE

When used as a mixing reset control, the 361 varies the supply water temperature based on the outdoor air temperature. The control takes into account the type of terminal unit that the system is using. Since different types of terminal units transfer heat to a space using different proportions of radiation, convection and conduction, the supply water temperature must be controlled differently. Once the control is told what type of terminal unit is used, the control varies the supply water temperature according to the type of terminal unit. This improves the control of the air temperature in the building.

MIXING TARGET TEMPERATURE (MIX TARGET)

When used as a mixing reset control, the MIX TARGET temperature is calculated from the *Characterized Heating Curve* settings, outdoor air temperature and optionally, indoor air temperature. When used as a setpoint control, the installer sets the MIX TARGET temperature. The control displays the temperature that it is currently trying to maintain as the mixing supply temperature. If the control does not have a mixing demand, “- -” is displayed as the MIX TARGET.

Section B2: Installer

OUTDOOR DESIGN (OUTDR DSGN)

The OUTDR DSGN is the outdoor air temperature that is the typical coldest temperature of the year where the building is located. This temperature is used when doing heat loss calculations for the building. If a cold outdoor design temperature is selected, the mixing supply temperature rises gradually as the outdoor temperature drops. If a warm outdoor design temperature is selected, the mixing supply temperature rises rapidly as the outdoor temperature drops.

SETPOINT OPERATION (MIX TARGET)

For setpoint operation, set the OUTDR DSGN to OFF. The MIX TARGET becomes the setpoint supply temperature that the control is to maintain. The MIX TARGET temperature is set by the installer in the ADJUST menu. An outdoor sensor is not required during this mode of operation.

ROOM OCC & UNOCC (ROOM)

The ROOM is the desired room temperature for the mixing zones, and it provides a parallel shift of the *Characterized Heating Curve*. The room temperature desired by the occupants is often different from the design indoor temperature (MIX INDR). If the room temperature is not correct, adjusting the ROOM setting increases or decreases the amount of heat available to the building. A ROOM setting is available for both the occupied (Day) and unoccupied (Night) modes.

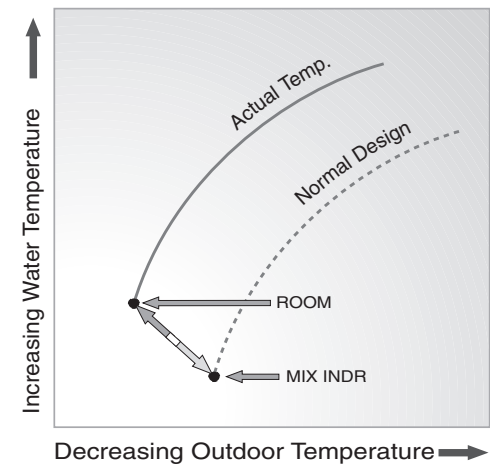
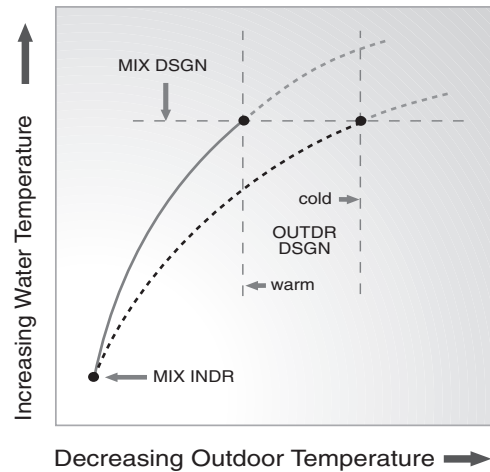

TERMINAL UNITS

When using a *Characterized Heating Curve*, the control requires the selection of a terminal unit. The terminal unit determines the shape of the *Characterized Heating Curve* according to how the terminal unit delivers heat into the building space (refer to Essay E 003). The 361 provides for selection between six different terminal unit types: two types of radiant floor heat, fancoil, fin-tube convactor, radiator and baseboard. When a terminal unit is selected, the control automatically loads the design supply temperature (MIX DSGN), maximum supply temperature (MIX MAX) and minimum supply temperature (MIX MIN). The factory defaults are listed below. To change defaults, refer to section B3. If a default has been changed, refer to section A to reload the factory defaults.

Terminal Unit	High Mass Radiant (1)	Low Mass Radiant (2)	Fancoil (3)	Fin-tube Convactor (4)	Radiator (5)	Baseboard (6)
MIX DSGN	120°F (49°C)	140°F (60°C)	190°F (88°C)	180°F (82°C)	160°F (71°C)	150°F (66°C)
MIX MAX	140°F (60°C)	160°F (71°C)	210°F (99°C)	200°F (93°C)	180°F (82°C)	170°F (77°C)
MIX MIN	OFF	OFF	100°F (38°C)	OFF	OFF	OFF

High Mass Radiant (1)

This type of a hydronic radiant floor is embedded in either a thick concrete or gypsum pour. This heating system has a large thermal mass and is slow acting.
Default values: MIX DSGN = 120°F (49°C), MIX MAX = 140°F (60°C), MIX MIN = OFF

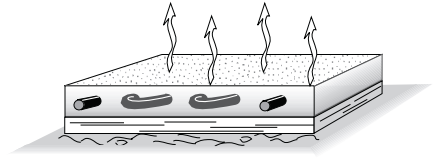

Low Mass Radiant (2)

This type of radiant heating system is either attached to the bottom of a wood sub-floor, suspended in the joist space, or sandwiched between the sub-floor and the surface. This type of radiant system has a relatively low thermal mass and responds faster than a high mass system.
Default values: MIX DSGN = 140°F (60°C), MIX MAX = 160°F (71°C), MIX MIN = OFF

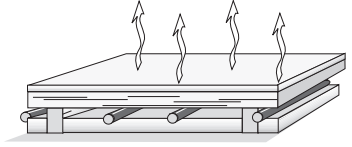

Fancoil (3)

A fancoil terminal unit or air handling unit (AHU) consists of a hydronic heating coil and either a fan or blower. Air is forced across the coil at a constant velocity by the fan or blower, and is then delivered into the building space.
Default values: MIX DSGN = 190°F (88°C), MIX MAX = 210°F (99°C),
MIX MIN = 100°F (38°C)

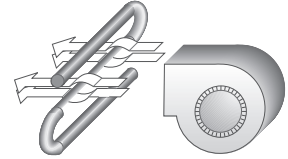

Fin-tube Convector (4)

A convector terminal unit is made up of a heating element with fins on it. This type of terminal unit relies on the natural convection of air across the heating element to deliver heated air into the space. The amount of natural convection to the space is dependant on the supply water temperature to the heating element and the room air temperature.
Default values: MIX DSGN = 180°F (82°C), MIX MAX = 200°F (93°C), MIX MIN = OFF

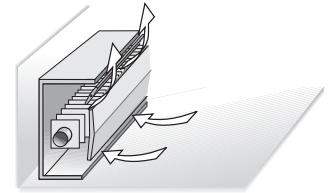

Radiator (5)

A radiator terminal unit has a large heated surface that is exposed to the room. A radiator provides heat to the room through radiant heat transfer and natural convection.
Default values: MIX DSGN = 160°F (71°C), MIX MAX = 180°F (82°C), MIX MIN = OFF

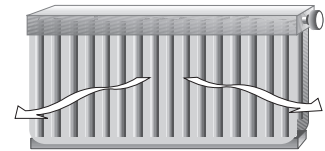

Baseboard (6)

A baseboard terminal unit is similar to a radiator, but has a low profile and is installed at the base of the wall. The proportion of heat transferred by radiation from a baseboard is greater than that from a fin-tube convector.
Default values: MIX DSGN = 150°F (66°C), MIX MAX = 170°F (77°C), MIX MIN = OFF



Section B3: Advanced

MIXING INDOOR (MIX INDR)

The MIX INDR is the room temperature used in the original heat loss calculations for the building. This setting establishes the beginning of the *Characterized Heating Curve* for the mixing zones.

MIXING DESIGN (MIX DSGN)

The MIX DSGN temperature is the supply water temperature required to heat the mixing zones when the outdoor air is as cold as the OUTDR DSGN temperature.

MIXING MAXIMUM (MIX MAX)

The MIX MAX sets the highest water temperature that the control is allowed to calculate as the MIX TARGET temperature. If the control does target the MIX MAX setting, and the MIX temperature is near the MIX MAX, the MAX segment will be displayed in the LCD while either the MIX TARGET temperature or the MIX temperature is being viewed.

MIXING MINIMUM (MIX MIN)

The MIX MIN is the lowest temperature that the control is allowed to use as a MIX TARGET temperature. During mild conditions, if the 361 calculates a MIX TARGET temperature that is below the MIX MIN setting, the MIX TARGET temperature is adjusted to match the MIX MIN setting. During this condition, the MIN segment will be displayed in the LCD when either the MIX TARGET or MIX temperature is being viewed. If an indoor sensor is used, and the 361 is operating at the MIX MIN temperature, the system pump is cycled using Pulse Width Modulation (PWM) with a 15 minute cycle length. By cycling the system pump and controlling the flow of supply water, the control provides an average supply water temperature to the system. This average temperature is equal to the original MIX TARGET. This minimizes overheating of the zone while the control is operating at the MIX MIN temperature.

WARM WEATHER SHUT DOWN (WWSD) OCC & UNOCC

When the outdoor air temperature rises above the WWSD setting, the 361 turns on the WWSD segment in the display. When the control is in Warm Weather Shut Down, the *Mixing Demand* pointer is displayed, if there is a demand. However, the control does not operate the heating system to satisfy this demand. If the control is in setpoint mode, the WWSD feature is not functional.

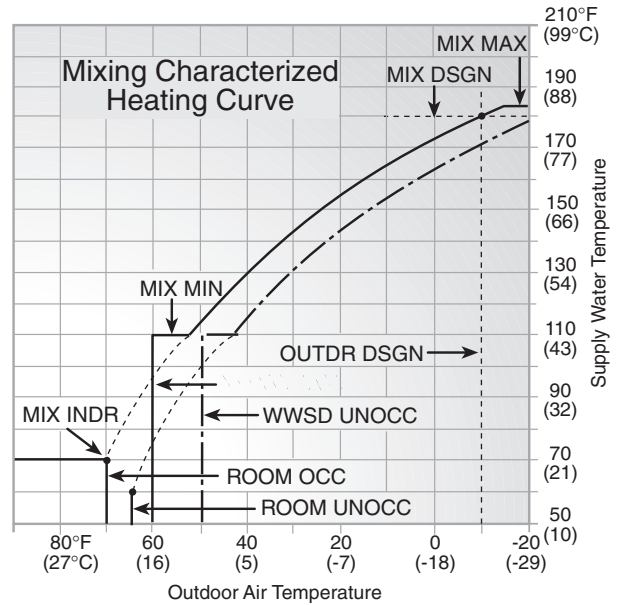

Section C: Boiler Operation

Section C1
General Operation

Section C2
Boiler Sensor
Placement

Section C1: General Operation

BOILER OPERATION

When the 361 determines that boiler operation is required, the *Boiler* contact terminals (9 and 10) close. While the *Boiler* contact is closed, the burner segment in the LCD is displayed.

BOILER MINIMUM (BOIL MIN)

Most boilers require a minimum water temperature in order to prevent flue gas condensation. The BOIL MIN adjustment is set to the boiler manufacturer's minimum recommended operating temperature. Only when the boiler temperature is measured by a boiler sensor can the 361 provide boiler protection. In this case, when the boiler is firing and the boiler temperature is below the BOIL MIN setting, the 361 turns on the MIN segment and reduces the heating load on the boiler by limiting the output of the variable speed injection pump. If the installed boiler is designed for low temperature operation, set the BOIL MIN adjustment to OFF.

BOILER PROTECTION

Refer to section A for a description of boiler protection.

Section C2: Boiler Sensor Placement

BOILER SENSOR ON THE SUPPLY (*Boiler Sensor DIP switch = Supply*)

The boiler sensor can be located on the boiler supply if the 361 is the only control that is operating the boiler. When in the supply mode, the 361 determines the required operating temperature of the boiler using *Boiler Load Reset*. With *Boiler Load Reset*, the 361 operates the boiler at the lowest possible supply temperature that is sufficient to satisfy the requirements of the variable speed injection pump. If this mode of operation is selected, the boiler pump should either operate continuously, or be operated in parallel with the system pump contact (*Sys Pmp*).

Note: The boiler pump should not be operated by the boiler's aquastat, as this may lead to improper cycling of the boiler because of inconsistent flow past the boiler supply sensor.

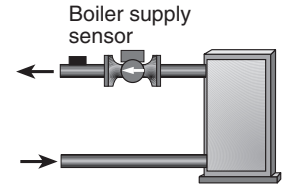

BOILER DIFFERENTIAL (BOIL DIFF)

An on / off heat source such as a boiler must be operated with a differential in order to prevent short cycling. When the boiler supply temperature drops below the bottom rail of the differential, the 361 closes the *Boiler* contact to fire the boiler. When the boiler supply temperature rises above the top rail of the differential, the 361 opens the *Boiler* contact to turn off the boiler. With the 361, either a fixed or automatic differential setting is selected. If automatic differential (**Ad**) is selected, the 361 automatically adjusts the boiler differential under the current load conditions to avoid short cycling.

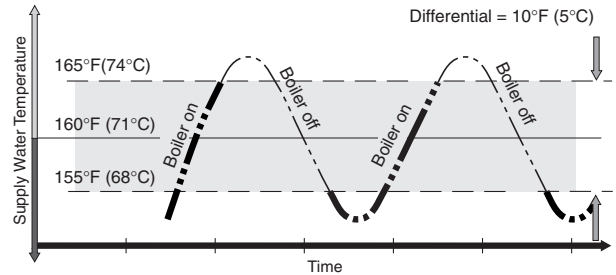

BOILER SENSOR ON THE RETURN (*Boiler Sensor DIP switch = Return*)

The boiler sensor should be located on the boiler return if the 361 is one of many controls that can call for boiler operation. When in the return mode, the 361 provides a boiler enable as described in the BOILER ENABLE section. The 361 no longer tries to control the boiler supply water temperature directly, but allows the boiler to operate at its operating aquastat setting when required. If this mode of operation is selected, the boiler pump should either operate continuously, or be operated in parallel with the system pump contact (*Sys Pmp*).

Note: The boiler pump should not be operated by the boiler's aquastat, as this may lead to improper cycling of the boiler because of inconsistent flow past the boiler sensor.

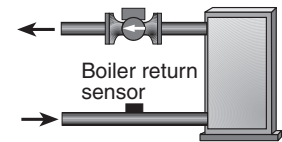

NO BOILER SENSOR

The 361 is capable of operating without a boiler sensor if desired. Without a boiler sensor, the 361 provides a boiler enable as described in the BOILER ENABLE section, but is unable to provide boiler protection. This type of application is typical if the 361 is drawing heat from a heat source that already incorporates some form of boiler protection.

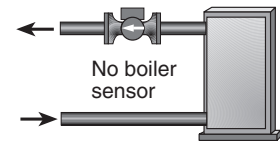

BOILER ENABLE (*30% Enable / 10% Enable*)

The 361 has a DIP switch that allows for the selection between a 30% boiler enable and a 10% boiler enable. This switch is only functional when the *Boiler Sensor DIP switch* is set to *Return*.

In the 30% position, the 361 closes the *Boiler* contact when the variable speed output exceeds 30%. The *Boiler* contact remains closed until the variable speed output reduces below 15%. This setting would normally be chosen for low mass boilers (copper fin-tube, etc.), or systems with low thermal mass in the loop between the boiler and the variable speed injection pump.

In the 10% position, the 361 closes the *Boiler* contact when the variable speed output exceeds 10%. The *Boiler* contact remains closed until the variable speed output reduces below 5%. This setting is normally chosen for high mass boilers (cast iron, steel fire-tube, etc.), or systems with large thermal mass in the loop between the boiler and the variable speed injection pump.

In order to prevent short cycling, the *Boiler* contact has a minimum on time, and a minimum off time.

Installation

CAUTION

Improper installation and operation of this control could result in damage to the equipment and possibly even personal injury. It is your responsibility to ensure that this control is safely installed according to all applicable codes and standards. This electronic control is not intended for use as a primary limit control. Other controls that are intended and certified as safety limits must be placed into the control circuit.

STEP ONE — GETTING READY

Check the contents of this package. If any of the contents listed are missing or damaged, please contact your wholesaler or tekmar sales representative for assistance.

Type 361 includes: One Mixing Control 361, One Outdoor Sensor 070, Two Universal Sensors 082, Data Brochures D 361, D 070, D 001, Application Brochure A 361, Essay E 021.

Note: Carefully read the details of the *Sequence of Operation* to ensure that you have chosen the proper control for your application.

STEP TWO — MOUNTING THE BASE

Remove the control from its base by pressing down on the release clip in the wiring chamber and sliding the control away from it. The base is then mounted in accordance with the instructions in the Data Brochure D 001.

STEP THREE — ROUGH-IN WIRING

All electrical wiring terminates in the control base wiring chamber. The base has standard 7/8" (22 mm) knockouts which accept common wiring hardware and conduit fittings. Before removing the knockouts, check the wiring diagram and select those sections of the chamber with common voltages. Do not allow the wiring to cross between sections, as the wires will interfere with safety dividers which should be installed at a later time.

Power must not be applied to any of the wires during the rough-in wiring stage.

- Install the Outdoor Sensor 070, Boiler Sensor 082, and Mixing Sensor 082 according to the instructions in the Data Brochure D 070, and run the wiring back to the control.
- If an Indoor Sensor 076 or 077 is used, install the indoor sensor according to the instructions in the Data Brochure D 074, and run the wiring back to the control.
- Run wire from other system components (pump, boiler, etc.) to the control.
- Run wires from the 120 V (ac) power to the control. Use a clean power source to ensure proper operation. Multi-strand 16 AWG wire is recommended for all 120 V (ac) wiring due to its superior flexibility and ease of installation into the terminals.

STEP FOUR — ELECTRICAL CONNECTIONS TO THE CONTROL

The installer should test to confirm that no voltage is present at any of the wires. Push the control into the base and slide it down until it snaps firmly into place.

Powered Input Connections

120 V (ac) Power

Connect the 120 V (ac) power supply to the *Power L* and *Power N* terminals (3 and 4). This connection provides power to the microprocessor and display of the control. As well, this connection provides power to the *Sys Pmp* terminal (5) and to the *Var Pmp* terminal (7) from the *Power L* terminal (3).

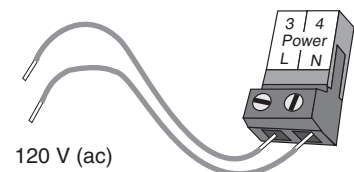

Mixing Demand

To generate a mixing demand, a voltage between 24 V (ac) and 240 V (ac) must be applied across the *Mixing Demand* terminals (1 and 2).

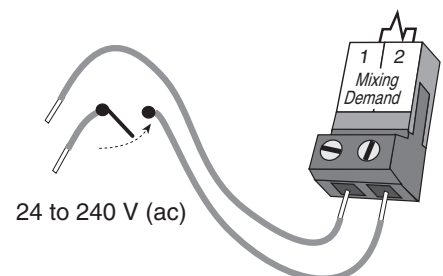

Output Connections

System Pump Contact (Sys Pmp)

The *Sys Pmp* output terminal (5) on the 361 is a powered output. When the relay in the 361 closes, 120 V (ac) is provided to the *Sys Pmp* terminal (5) from the *Power L* terminal (3). To operate the system pump, connect one side of the system pump circuit to terminal (5), and the second side of the pump circuit to the neutral (N) terminal (6).

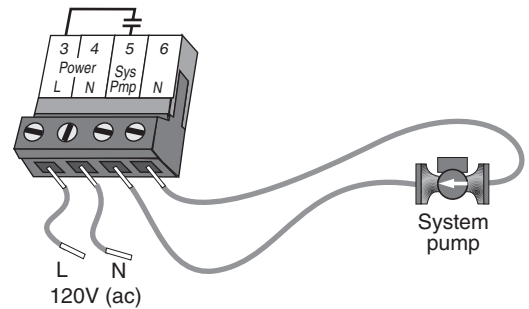

Variable Speed Injection Pump (Var Pmp)

The 361 can vary the speed of a permanent capacitor, impedance protected, or equivalent pump motor that has a locked rotor current of less than 2.4 A. Most small wet rotor circulators are suitable as described in Essay E 021. The 361 has an internal overload protection fuse which is rated at 2.5 A 250 V (ac). Contact your tekmar sales representative for details on the repair procedures if this fuse is blown.

The *Var Pmp* terminal (7) on the 361 is a powered output. Power is supplied to the *Var Pmp* terminal (7) from the *Power L* terminal (3). To operate the variable speed injection pump, connect one side of the pump circuit to *Var Pmp* terminal (7), and the second side of the pump circuit to the neutral (N) terminal (8).

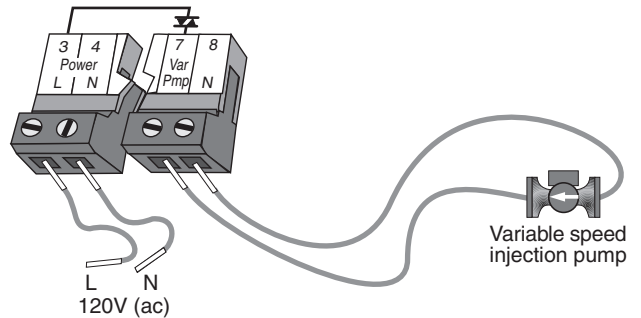

Boiler Contact

The *Boiler* terminals (9 and 10) are an isolated output in the 361. There is no power available on these terminals from the control. These terminals are to be used as a switch to either make or break the boiler circuit. When the 361 requires the boiler to fire, it closes the contact between terminals 9 and 10.

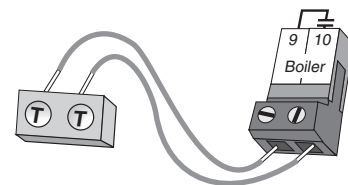

Sensor and Unpowered Input Connections

Do not apply power to these terminals as this will damage the control.

Outdoor Sensor

Connect the two wires from the Outdoor Sensor 070 to the *Com* and *Out* terminals (15 and 16). The outdoor sensor is used by the 361 to measure the outdoor air temperature.

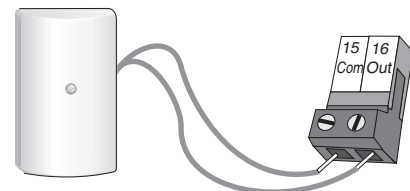

Boiler Sensor

Connect the two wires from the Boiler Sensor 082 to the *Com* and *Boil* terminals (12 and 13). The boiler sensor is used by the 361 to measure the boiler temperature.

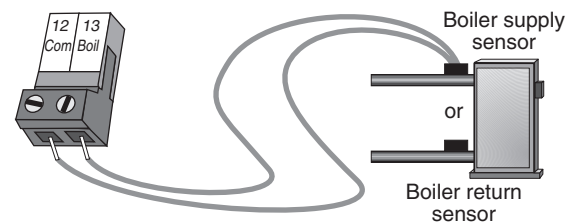

Mixing Sensor

Connect the two wires from the Mixing Sensor 082 to the *Com* and *Mix* terminals (12 and 14). The mixing sensor is used by the 361 to measure the mixed supply water temperature after the variable speed injection pump. Normally the sensor is attached to the pipe downstream of the system pump.

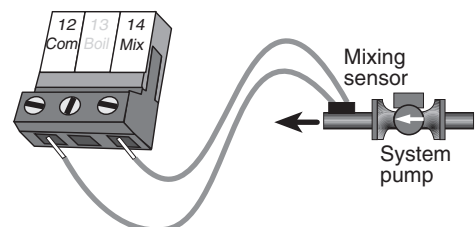

Indoor Sensor

If an indoor sensor is used, connect the two wires from the sensor to the *Com* and *Indr* terminals (15 and 17). The indoor sensor is used by the 361 to measure the room air temperature.

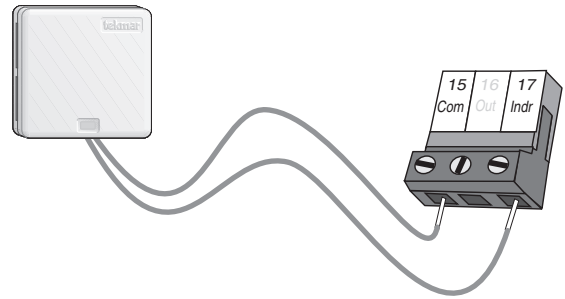

Unoccupied Switch

If an external timer (tekmar Timer 032) or switch is used, connect the two wires from the external switch to the *UnO Sw* and *Com* terminals (11 and 12). When these two terminals are shorted together, the control registers an unoccupied signal.

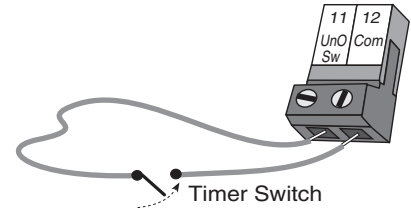

STEP FIVE TESTING THE WIRING

Each terminal block **must be unplugged** from its header on the control before power is applied for testing. To remove a terminal block, pull it straight down from the control.

The following tests are to be performed using standard testing practices and procedures, and should only be carried out by properly trained and experienced persons.

A good quality electrical test meter, capable of reading from at least 0 - 300 V (ac) and at least 0 - 2,000,000 Ohms, is essential to properly test the wiring and sensors.

Test The Sensors

In order to test the sensors, the actual temperature at each sensor location must be measured. A good quality digital thermometer with a surface temperature probe is recommended for ease of use and accuracy. Where a digital thermometer is not available, a spare sensor can be strapped alongside the one to be tested and the readings compared. Test the sensors according to the instructions in the Data Brochure D 070.

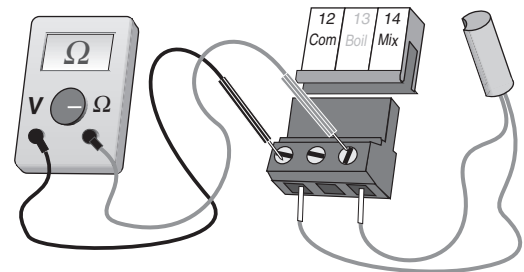

Test The Power Supply

Make sure exposed wires and bare terminals are not in contact with other wires or grounded surfaces. Turn on the power and measure the voltage between the *Power L* and *Power N* terminals (3 and 4) using an AC voltmeter. The reading should be between 108 and 132 V (ac).

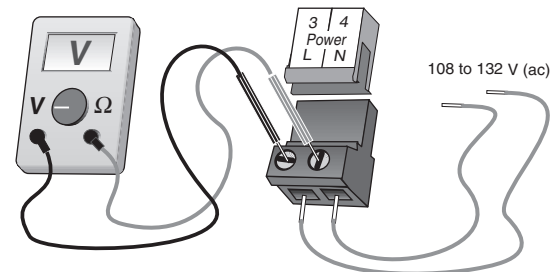

Test The Powered Inputs

Mixing Demand

Measure the voltage between the *Mixing Demand* terminals (1 and 2). When the mixing demand device calls for heat, you should measure between 20 and 260 V (ac) at the terminals. When the mixing demand device is off, you should measure less than 5 V (ac).

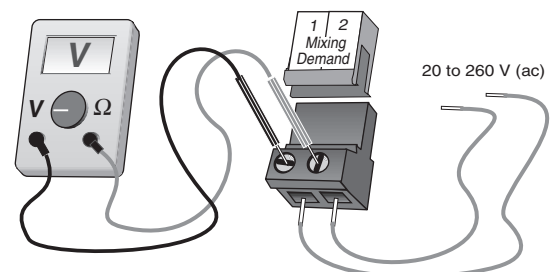

Test The Outputs

System Pump (Sys Pmp)

If a system pump is connected to the *Sys Pmp* terminal (5), make sure that power to the terminal block is off, and install a jumper between the *Power L* and the *Sys Pmp* terminals (3 and 5). Install a second jumper between *Power N* and *N* terminals (4 and 6). When power is applied to the *Power L* and *Power N* terminals (3 and 4), the system pump should start. If the pump does not turn on, check the wiring between the terminal block and pump, and refer to any installation or troubleshooting information supplied with the pump. If the pump operates properly, disconnect the power and remove the jumpers.

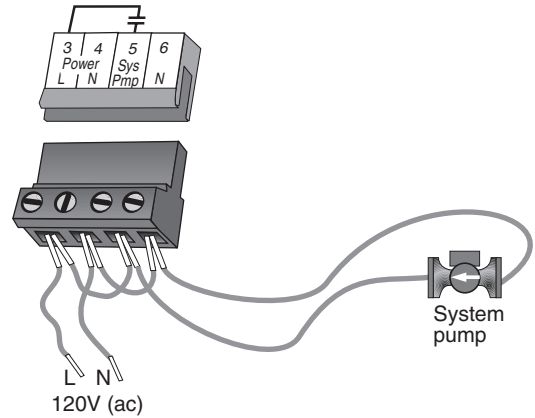

Variable Speed Injection Pump (Var Pmp)

If a variable speed injection pump is connected to the *Var Pmp* terminal (7), make sure that power to the terminal block is off, and install a jumper between the *Power L* and the *Var Pmp* terminals (3 and 7). Install a second jumper between *Power N* and *N* terminals (4 and 8). When the variable speed pump circuit is powered up, the variable speed pump should operate at full speed. If the pump does not operate, check the wiring between the terminal block and the pump, and refer to any installation or troubleshooting information supplied with the pump. If the pump operates properly, disconnect the power and remove the jumpers.

Boiler

If the boiler circuit is connected to the *Boiler* terminals (9 and 10), make sure power to the boiler circuit is off, and install a jumper between the terminals. When the boiler circuit is powered up, the boiler should fire. If the boiler does not turn on, refer to any installation or troubleshooting information supplied with the boiler. (The boiler may have a flow switch that prevents firing until the boiler loop pump is running). If the boiler operates properly, disconnect the power and remove the jumper.

Connecting The Control

Make sure all power to the devices and terminal blocks is off, and remove any remaining jumpers from the terminals.

Reconnect the terminal blocks to the control by carefully aligning them with their respective headers on the control, and then pushing the terminal blocks into the headers. The terminal blocks should snap firmly into place.

Install the supplied safety dividers between the unpowered sensor inputs and the powered 120 V (ac) or 24 V (ac) wiring chambers.

Apply power to the control. The operation of the control on power up is described in the *Sequence of Operation* section of this brochure.

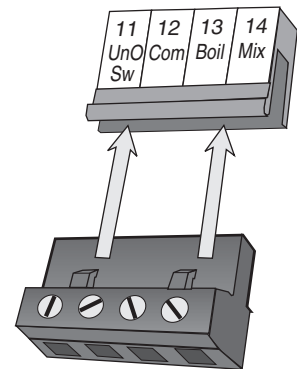

DIP Switch Settings

The DIP Switch settings on the control are very important and should be set to the appropriate settings prior to making any adjustments to the control through the user interface. The DIP switch settings change the items that are available to be viewed and / or adjusted in the user interface.

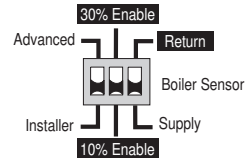

ADVANCED / INSTALLER

The *Advanced / Installer* DIP switch is used to select which items are available to be viewed and / or adjusted in the user interface.

30% ENABLE / 10% ENABLE

The position of the *30% Enable / 10% Enable* DIP switch determines at which pump output the control will close the *Boiler* contact under normal conditions. This switch is only operational if the *Boiler Sensor* DIP switch is set to *Return*. Refer to section C2.

BOILER SENSOR (RETURN / SUPPLY)

The *Boiler Sensor* DIP switch selects the installation location for the boiler sensor. When the boiler sensor is installed on the supply side of the boiler loop, the DIP switch must be set to *Supply*. The boiler aquastat should be set at least 20 °F (11 °C) higher than the required design boiler water temperature. The boiler is controlled as described in section C.

For systems where the 361 provides a heat demand to an external boiler control, the boiler sensor should be installed on the return side of the boiler loop. When the boiler sensor is installed on the return side of the boiler loop, the DIP switch must be set to *Return*. The 361 only enables the boiler when the output of the variable speed injection pump exceeds the boiler enable DIP switch setting. The *Boiler* contact is controlled as described in section C. The boiler's operating temperature is controlled by its aquastat, or an external boiler reset control.

Quick Setup

The quick setup can be used for both outdoor reset and setpoint operation. To enter the installer programming mode, set the *Advanced / Installer* DIP switch to *Installer*.

OUTDOOR RESET

Access the ADJUST menu by pressing and holding simultaneously for 1 second, all three buttons. The display will now show the word ADJUST in the top right corner.

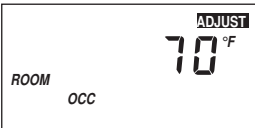

The ROOM OCC adjustment is the first item displayed. Use the ▲ or ▼ button to set the ROOM temperature. The ROOM OCC setting is set to the desired room air temperature during the occupied (Day) mode.

Note: To increase or decrease space temperature during the occupied (Day) mode, only adjust the ROOM OCC setting.

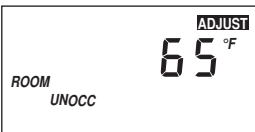

Press and release the **Item** button to advance to the ROOM UNOCC adjustment. Use the ▲ or ▼ button to set the desired temperature. The ROOM UNOCC setting is set to the desired room air temperature during the unoccupied (Night) mode.

Note: To increase or decrease space temperature during the unoccupied (Night) mode, only adjust the ROOM UNOCC setting.



Press and release the **Item** button to advance to the OUTDR DSGN adjustment. Use the ▲ or ▼ button to set the outdoor design temperature. The OUTDR DSGN setting is set to the typical coldest temperature of the year.



Press and release the **Item** button to advance to the *Terminal Unit* adjustment. Use the ▲ or ▼ button to select the desired terminal unit. The terminal unit number corresponds to the type of terminal that is being used. The table below lists the terminal units and their default values.

Terminal Unit	High Mass Radiant (1)	Low Mass Radiant (2)	Fancoil (3)	Fin-tube Convectector (4)	Radiator (5)	Baseboard (6)
MIX DSGN	120°F (49°C)	140°F (60°C)	190°F (88°C)	180°F (82°C)	160°F (71°C)	150°F (66°C)
MIX MAX	140°F (60°C)	160°F (71°C)	210°F (99°C)	200°F (93°C)	180°F (82°C)	170°F (77°C)
MIX MIN	OFF	OFF	100°F (38°C)	OFF	OFF	OFF



Press and release the **Item** button to advance to the units adjustment. Use the **▲** or **▼** button to set the scale to °F or °C.

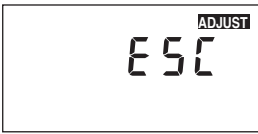

To exit the ADJUST menu, press and release the **Item** button to advance to the ESC item. Then either press the **▲** or **▼** button, or leave the buttons alone for 20 seconds.

SETPOINT CONTROL

Access the ADJUST menu by pressing and holding simultaneously for 1 second, the **Item**, **▲** and **▼** buttons. The display will now show the word ADJUST in the top right corner.

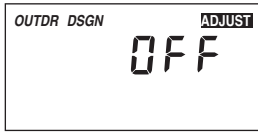

Press and release the **Item** button to advance to the OUTDR DSGN adjustment. Press and hold the **▲** button until OFF is displayed.



Press and release the **Item** button to advance to the MIX TARGET adjustment. Use the **▲** or **▼** button to select the desired temperature. The MIX TARGET setting is set to the desired setpoint supply temperature.

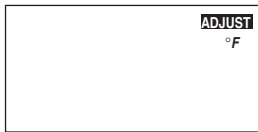

Press and release the **Item** button to advance to the units adjustment. Use the **▲** or **▼** button to set the scale to °F or °C.

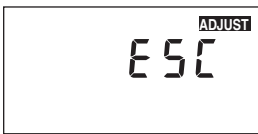

To exit the ADJUST menu, press and release the **Item** button to advance to the ESC item. Then either press the **▲** or **▼** button, or leave the buttons alone for 20 seconds.



View Menu (1 of 1)

Display	Section			Description	Range
	Section	Installer	Advanced		
		●	●	Current outdoor air temperature as measured by the outdoor sensor. This is also the default display for the control. (OUTDR DSGN ≠ OFF)	-67 to 149°F (-55 to 65°C)
	B1	●	●	Current room air temperature as measured by the indoor sensor. (Indoor sensor is present)	23 to 113°F (-5 to 45°C)
	B3	●	●	Current mixed supply water temperature as measured by the mixing sensor.	14 to 266°F (-10 to 130°C)
	B1 B2 B3	●	●	Target mixed supply is the temperature the control is currently trying to maintain at the mixing sensor.	---, 14 to 266°F (---, -10 to 130°C)
		●	●	Current boiler temperature as measured by the boiler sensor. (Boiler sensor is present)	14 to 266°F (-10 to 130°C)

Adjust Menu (1 of 2)

Display	Section			Description	Range	Actual Setting
	Installer	Advanced				
ROOM OCC 70 ^{°F} ADJUST	B2	●	●	The desired room air temperature during an occupied (Day) period. (OUTDR DSGN ≠ OFF)	35 to 100°F (2 to 38°C)	
ROOM UNOCC 65 ^{°F} ADJUST	B2	●	●	The desired room air temperature during an unoccupied (Night) period. (OUTDR DSGN ≠ OFF)	35 to 100°F (2 to 38°C)	
MIX TARGET 98 ^{°F} ADJUST	B2	●	●	Mixing setpoint temperature. (OUTDR DSGN = OFF)	60 to 200°F (16 to 93°C)	
OUTDR DSGN 10 ^{°F} ADJUST	B2	●	●	The design outdoor air temperature used in the heat loss calculation for the heating system. For setpoint operation, set the OUTDR DSGN to OFF.	-60 to 32°F, OFF (-51 to 0°C, OFF)	
Terminal Unit 1 ADJUST	B2	●	●	The type of terminal units that are being used in the heating system. (OUTDR DSGN ≠ OFF)	1 (High Mass Radiant), 2 (Low Mass Radiant), 3 (Fancoil), 4 (Fin-tube Convectector), 5 (Radiator), 6 (Baseboard)	
MIX INDR 70 ^{°F} ADJUST	B3		●	The design indoor air temperature used in the heat loss calculation for the heating system. (OUTDR DSGN ≠ OFF)	35 to 100°F (2 to 38°C)	
DSGN MIX 120 ^{°F} ADJUST	B3		●	The design supply water temperature used in the heat loss calculation for the heating system. (OUTDR DSGN ≠ OFF)	70°F to 220°F (21 to 104°C)	
MIX MAX 140 ^{°F} ADJUST	B3		●	The maximum supply temperature for the mixing system. (OUTDR DSGN ≠ OFF)	80 to 210°F (27 to 99°C)	
MIX MIN OFF ADJUST	B3		●	The minimum supply temperature for the mixing system. (OUTDR DSGN ≠ OFF)	OFF, 35 to 150°F (OFF, 2 to 65°C)	
BOIL MIN 140 ^{°F} ADJUST	C1		●	The minimum temperature allowed for the boiler target temperature. (Boiler sensor is present)	OFF, 80 to 180°F (OFF, 27 to 82°C)	
BOIL DIFF Ad ADJUST	C2		●	The differential that the control is to use when it is operating the boiler. (Boiler Sensor DIP switch = Supply AND Boiler sensor is present)	Ad, 2 to 42°F (Ad, -17 to 6°C)	

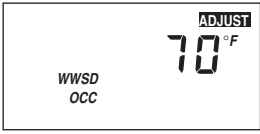
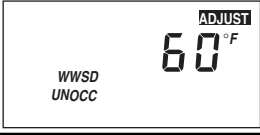
Adjust Menu (2 of 2)

Display	Section			Description	Range	Actual Setting
	Installer	Advanced				
	B3	●		The system's warm weather shut down during the occupied (Day) period.	35 to 100°F, OFF (2 to 38°C, OFF)	
	B3	●		The system's warm weather shut down during the unoccupied (Night) period.	35 to 100°F, OFF (2 to 38°C, OFF)	
		●	●	The units of measure that all of the temperatures are to be displayed in the control.	°F, °C	
		●	●	This item exits the ADJUST menu by pressing either the ▲ or ▼ button.		

Testing the Control

The Mixing Control 361 has a built-in test routine which is used to test the main control functions. The 361 continually monitors the sensors, and displays an error message whenever a fault is found. See the following pages for a list of the 361's error messages and possible causes. When the **Test** button is pressed, the test light is turned on. The individual outputs and relays are tested in the following test sequence.

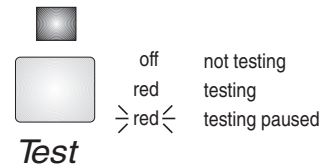

TEST SEQUENCE

Each step in the test sequence lasts 10 seconds.

During the test routine, the test sequence may be paused by pressing the **Test** button. Only if there is a mixing demand can the control be paused in a step. If the **Test** button is not pressed again for 5 minutes while the test sequence is paused, the control exits the entire test routine. If the test sequence is paused, the **Test** button can be pressed again to advance to the next step. This can also be used to rapidly advance through the test sequence. To reach the desired step, repeatedly press and release the **Test** button until the appropriate device and segment in the display turn on.

Step 1 - The injection pump operates at 100% for 10 seconds. After 10 seconds, the injection pump is shut off.

Step 2 - The system pump (*Sys Pmp*) is turned on for 10 seconds.

Step 3 - The *Boiler* contact is turned on for 10 seconds. After 10 seconds, the *Boiler* and *Sys Pmp* contacts are shut off.

Step 4 - After the test sequence is completed, the control resumes its normal operation.

Troubleshooting

When troubleshooting any heating system, it is always a good idea to establish a set routine to follow. By following a consistent routine, many hours of potential headaches can be avoided. Below is an example of a sequence that can be used when diagnosing or troubleshooting problems in a hydronic heating system.

Establish the Problem

Establish the problem. Get as much information from the customer as possible about the problem. Is there too much heat, not enough heat, or no heat? Is the problem only in one particular zone or area of the building, or does the problem affect the entire system? Is this a consistent problem or only intermittent? How long has the problem existed for? This information is critical in correctly diagnosing the problem.

Understand the Sequence of Operation

Understand the sequence of operation of the system. If a particular zone is not receiving enough heat, which pumps or valves in the system must operate in order to deliver heat to the affected zone? If the zone is receiving too much heat, which pumps, valves, or check valves must operate in order to stop the delivery of heat?

Use the Test Routine

Press the **Test** button on the control and follow the control through the test sequence as described in the Testing section. Pause the control as necessary to ensure that the correct device is operating as it should.

Sketch the Piping in the System

Sketch the piping of the system. This is a relatively simple step that tends to be overlooked, however, it can often save hours of time in troubleshooting a system. Note flow directions in the system paying close attention to the location of pumps, check valves, pressure bypass valves, and mixing valves. Ensure correct flow direction on all pumps. This is also a very useful step if additional assistance is required.

Document the Control

Document the control for future reference. Before making any adjustments to the control, note down all of the items that the control is currently displaying. This includes items such as error messages, current temperatures and settings, and which devices should be operating as indicated by the LCD. This information is an essential step if additional assistance is required to diagnose the problem.

Isolate the Problem

Isolate the problem between the control and the system. Now that the sequence of operation is known and the system is sketched, is the control operating the proper pumps and valves at the correct times? Is the control receiving the correct signals from the system as to when it should be operating? Are the proper items selected in the menus of the control for the device that is to be operated?

Test the Contacts Voltages & Sensors

Test the contacts, voltages and sensors. Using a multimeter, ensure that the control is receiving adequate voltage to the power terminals and the demand terminals as noted in the technical data. Use the multimeter to determine if the internal contacts on the control are opening and closing correctly. Follow the instructions in the Testing the Wiring section to simulate closed contacts on the terminal blocks as required. Test the sensors and their wiring as described in the sensor Data Brochures.

Error Messages

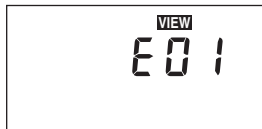

The control was unable to read a piece of information from its EEPROM. This error can be caused by a noisy power source. The control will load the factory defaults and stop operation until all the settings are verified.

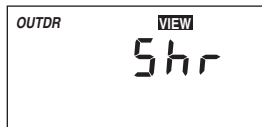

The control is no longer able to read the outdoor sensor due to a short circuit. In this case the control assumes an outdoor temperature of 32°F (0°C) and continues operation. Locate and repair the problem as described in the Data Brochure D 070. To clear the error message from the control after the sensor has been repaired, press the **Item** button.



The control is no longer able to read the outdoor sensor due to an open circuit. In this case the control assumes an outdoor temperature of 32°F (0°C) and continues operation. Locate and repair the problem as described in the Data Brochure D 070. To clear the error message from the control after the sensor has been repaired, press the **Item** button.

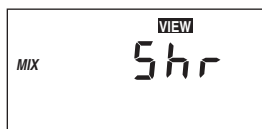

The control is no longer able to read the mixing supply sensor due to a short circuit. In this case the control will operate the variable speed injection pump at a fixed output as long as there is a mixing demand. Locate and repair the problem as described in the Data Brochure D 070. To clear the error message from the control after the sensor has been repaired, press the **Item** button.

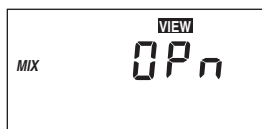

The control is no longer able to read the mixing supply sensor due to a short circuit. In this case the control will operate the variable speed injection pump at a fixed output as long as there is a mixing demand. Locate and repair the problem as described in the Data Brochure D 070. To clear the error message from the control after the sensor has been repaired, press the **Item** button.

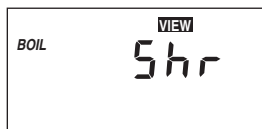

The control is no longer able to read the boiler sensor due to a short circuit. If the BOIL MIN adjustment is higher than 100°F (38°C), the control operates the *Boiler* contact as a boiler enable (see section C). The boiler temperature is then limited by the operating aquastat. If the BOIL MIN adjustment is lower than 100°F (38°C), the control does not operate the *Boiler* contact. Locate and repair the problem as described in the Data Brochure D 070. To clear the error message from the control after the sensor has been repaired, press the **Item** button.

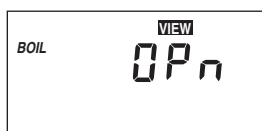

The control is no longer able to read the boiler sensor due to an open circuit. If the BOIL MIN adjustment is higher than 100°F (38°C), the control operates the *Boiler* contact as a boiler enable (see section C). The boiler temperature is then limited by the operating aquastat. If the BOIL MIN adjustment is lower than 100°F (38°C), the control does not operate the *Boiler* contact. Locate and repair the problem as described in the Data Brochure D 070. If the boiler sensor is deliberately removed, the control must be powered down, and then powered back up. To clear the error message from the control after the sensor has been repaired, press the **Item** button.

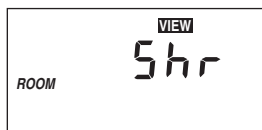

The control is no longer able to read the indoor sensor due to a short circuit. The control will continue to operate as if there was nothing connected to the indoor sensor input. Locate and repair the problem as described in the Data Brochure D 074. To clear the error message from the control after the sensor has been repaired, press the **Item** button.

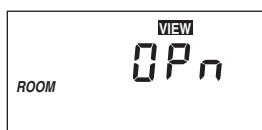

The control is no longer able to read the indoor sensor due to an open circuit. The control will continue to operate as if there was nothing connected to the indoor sensor input. Locate and repair the problem as described in the Data Brochure D 074. If the indoor sensor is deliberately removed, the control must be powered down, and then powered back up. To clear the error message from the control after the sensor has been repaired, press the **Item** button.

Technical Data

Mixing Control 361 Variable Speed

Literature	— D 361, A 361's, D 001, D 070, E 021.
Control	— Microprocessor PID control; This is not a safety (limit) control .
Packaged weight	— 3.0 lb. (1380 g), Enclosure A, blue PVC plastic
Dimensions	— 6-5/8" H x 7-9/16" W x 2-13/16" D (170 x 193 x 72 mm)
Approvals	— CSA C US, CSA 22.2 No 24 and UL 873, meets class B: ICES & FCC Part 15.
Ambient conditions	— Indoor use only, 32 to 102°F (0 to 39°C), < 90% RH non-condensing.
Power supply	— 120 V (ac) ±10%, 50/60 Hz, 1650 VA
Variable Pump	— 240 V (ac) 2.4 A (FLA) 5 A (LRA), fuse T2.5 A
Relays	— 240 V (ac) 10 A 1/3 hp
Demand	— 20 to 260 V (ac) 2 VA
Sensors included	— NTC thermistor, 10 kΩ @ 77°F (25°C ±0.2°C) β=3892 Outdoor Sensor 070 and 2 of Universal Sensor 082.
Optional devices	— tekmar type #: 032, 076, 077.

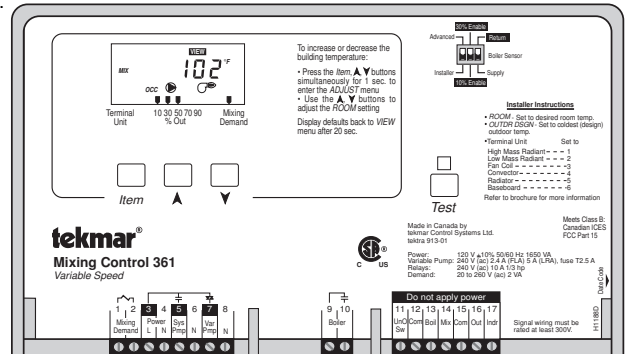

The installer must ensure that this control and its wiring are isolated and/or shielded from strong sources of electromagnetic noise. Conversely, this Class B digital apparatus complies with Part 15 of the FCC Rules and meets all requirements of the Canadian Interference-Causing Equipment Regulations. However, if this control does cause harmful interference to radio or television reception, which is determined by turning the control off and on, the user is encouraged to try to correct the interference by reorienting or relocating the receiving antenna, relocating the receiver with respect to this control, and/or connecting the control to a different circuit from that to which the receiver is connected.

Cet appareil numérique de la classe B respecte toutes les exigences du Règlement sur le matériel brouilleur du Canada.

Caution The nonmetallic enclosure does not provide grounding between conduit connections. Use grounding type bushings and jumper wires.

Attention Un boîtier nonmétallique n'assure pas la continuité électrique des conduits. Utiliser des manchons ou des fils de accord spécialement conçus pour la mise à la terre.

Limited Warranty and Product Return Procedure

Limited Warranty The liability of tekmar Control Systems Ltd. and tekmar Control Systems, Inc. ("tekmar") under this warranty is limited. The purchaser, by taking receipt of the tekmar product ("product"), acknowledges receipt of the terms of the warranty and acknowledges that it has read and understands same.

tekmar warrants each tekmar product against defects in workmanship and materials, if the product is installed and used in compliance with tekmar's instructions. The warranty period is for a period of twenty-four (24) months from the production date if the product is not installed during that period, or twelve (12) months from the documented date of installation if installed within twenty-four (24) months from the production date.

The liability of tekmar under this warranty shall be limited to, at tekmar's sole discretion: the cost of parts and labor provided by tekmar to repair defects in materials and/or workmanship of the defective product; or to the exchange of the defective product for a replacement product; or to the granting of credit limited to the original cost of the defective product, and such repair, exchange or credit shall be the sole remedy available from tekmar, and, without limiting the foregoing in any way, tekmar is not responsible, in contract, tort or strict product liability, for any other losses, costs, expenses, inconveniences, or damages, whether direct, indirect, special, secondary, incidental or consequential, arising from ownership or use of the product, or from defects in workmanship or materials, including any liability for fundamental breach of contract.

This warranty applies only to those products returned to tekmar during the warranty period. This warranty does not cover the cost of the parts or labor to remove or transport the defective product, or to reinstall the repaired or

replacement product. Returned products that are not defective are not covered by this warranty.

This warranty does not apply if the product has been damaged by negligence by persons other than tekmar, accident, fire, Act of God, abuse or misuse; or has been damaged by modifications, alterations or attachments made subsequent to purchase which have not been authorized by tekmar; or if the product was not installed in compliance with tekmar's instructions and the local codes and ordinances; or if due to defective installation of the product; or if the product was not used in compliance with tekmar's instructions.

This warranty is in lieu of all other warranties, express or implied, which the Governing Law (being the law of British Columbia) allows parties to contractually exclude, including, without limitation, warranties of merchantability, fitness for a particular purpose, durability or description of the product, its non-infringement of any relevant patents or trademarks, and its compliance with or non-violation of any applicable environmental, health or safety legislation; the term of any other warranty not hereby contractually excluded is limited such that it shall not extend beyond twenty-four (24) months from the production date, to the extent that such limitation is allowed by the Governing Law.

Product Return Procedure Products that are believed to have defects in workmanship or materials must be returned, together with a written description of the defect, to the tekmar representative for that territory. If the address of the representative is not known, please request it from tekmar at the telephone number listed below.



tekmar Control Systems Ltd., Canada
tekmar Control Systems, Inc., U.S.A.
**Head Office: 5100 Silver Star Road
Vernon, B.C. Canada V1B 3K4
Tel. (250) 545-7749 Fax. (250) 545-0650
Web Site: www.tekmarcontrols.com**

