

Installation & Operation Manual

Thermostat 518

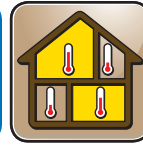

Zoning

518_D

06/16

Replaces: 03/13

Introduction

The Thermostat 518 accurately controls the room temperature for a hydronic heating zone using Pulse Width Modulation (PWM) technology. Simple up and down buttons and a display with large type make this thermostat easy to read and use. The 518 automatically detects a single auxiliary sensor to measure either outdoor, floor or remote room temperature. This easy to install thermostat is a direct replacement for tekmar Thermostats 507 and 508.

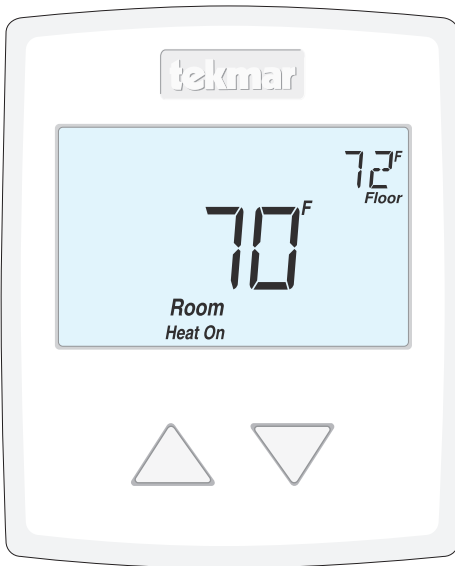

Energy Saving Features

- Away Input
- Auto Heating Cycle

Additional Features

- Radiant Floor Heating
- Pulse Width Modulation
- Auxiliary Sensor Input
- Outdoor & Floor Temperature Display
- Backlight
- Freeze Protection

Table of Contents

Important Safety Information	2	Sequence of Operation.....	8
Installation	3	Heating Operation.....	8
Preparation	2	Programmable Settings.....	9
Removing The Thermostat Base.....	3	Troubleshooting	10
Mounting The Thermostat.....	4	Error Messages	10
Thermostat Wiring	5	Frequently Asked Questions.....	11
Testing the Thermostat Wiring.....	6	Technical Data	11
User Interface	7	Limited Warranty and Product	
Home Screen.....	7	Return Procedure	12
Symbols Description.....	7		

Important Safety Information



This is a safety-alert symbol. The safety alert symbol is shown alone or used with a signal word (DANGER, WARNING, or CAUTION), a pictorial and/or a safety message to identify hazards.

When you see this symbol alone or with a signal word on your equipment or in this Manual, be alert to the potential for death or serious personal injury.



This pictorial alerts you to electricity, electrocution, and shock hazards.

WARNING

This symbol identifies hazards which, if not avoided, could result in death or serious injury.

CAUTION

This symbol identifies hazards which, if not avoided, could result in minor or moderate injury.

NOTICE

This symbol identifies practices, actions, or failure to act which could result in property damage or damage to the equipment.

WARNING



Read Manual and all product labels BEFORE using the equipment. Do not use unless you know the safe and proper operation of this equipment. Keep this Manual available for easy access by all users. Replacement Manuals are available at tekmarControls.com

NOTICE

Do not attempt to service the thermostat. There are no user serviceable parts inside the thermostat. Attempting to do so voids warranty.

⚠ WARNING

- It is the installer's responsibility to ensure that this thermostat is safely installed according to all applicable codes and standards.
- Improper installation and operation of this thermostat could result in damage to the equipment and possibly even personal injury or death.
- This thermostat is not intended for use as a primary limit control. Other controls that are intended and certified as safety limits must be placed into the control circuit.

Installation

Preparation

Tools Required

- tekmar or jeweller screwdriver
- Wire Stripper
- Phillips head screwdriver

Materials Required

- 18 AWG LVT Solid Wire (Low Voltage Connections)

Installation Location

Choose the placement of the thermostats early in the construction process to enable proper wiring during rough-in.

NOTICE

Consider the following:

- Interior Wall.
- Keep dry. Avoid potential leakage onto the control.
- Relative Humidity less than 90%. Non-condensing environment.
- No exposure to extreme temperatures beyond 32-122°F (0-50°C).
- No draft, direct sun, or other cause for inaccurate temperature readings.
- Away from equipment, appliances, or other sources of electrical interference.
- Easy access for wiring, viewing, and adjusting the display screen.
- Approximately 5 feet (1.5 m) off the finished floor.
- The maximum length of wire is 500 feet (150 m).
- Strip wire to 3/8" (10 mm) for all terminal connections.
- Use standard 8 conductor, 18 AWG wire.

Removing The Thermostat Base

To remove the thermostat base:

- Locate the tab on the bottom of the thermostat.
- Push the tab with either your thumb or with a screwdriver.
- Lift the thermostat front away from the thermostat's base.

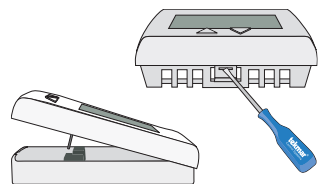

Mounting The Thermostat

⚠ WARNING



To prevent the risk of personal injury and/or death, make sure power is not applied to the thermostat until it is fully installed and ready for final testing. All work must be done with power to the circuit being worked on turned off.

Please be aware local codes may require this thermostat to be installed or connected by an electrician.

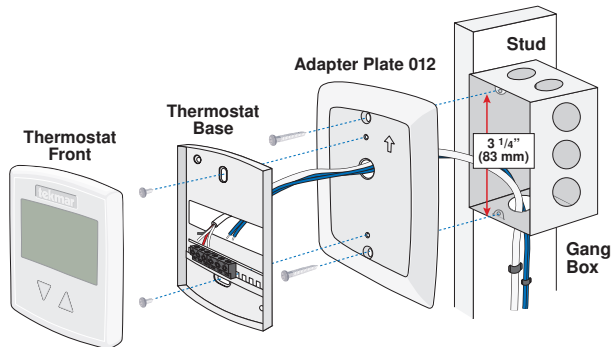

If a single gang box is used:

- Adapter Plate 012 is required (sold separately).
- Feed the wiring through the hole in the adaptor plate and the thermostat base.
- Fasten the adaptor plate to the gang box.
- Fasten the base of the thermostat to the adaptor plate.
- Terminate wiring to the wiring strip. Do not over tighten wiring screws. Hand tighten only.
- Push the thermostat front onto the thermostat base.

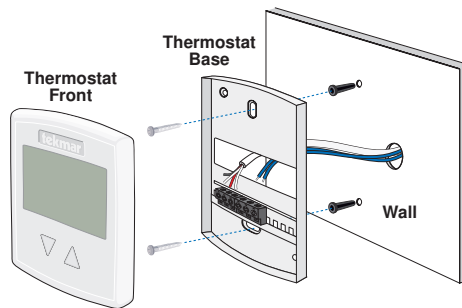

If mounting directly to the wall:

- Drill holes using a 3/16" drill bit and install the wall anchors.
- Feed the wiring through the large hole in the thermostat base.
- Fasten the thermostat base to the wall using the wood screws to the wall anchors.
- Terminate wiring to the wiring strip. Do not over tighten wiring screws. Hand tighten only.
- Push the thermostat front onto the thermostat base.

Thermostat Wiring

Zone Valve

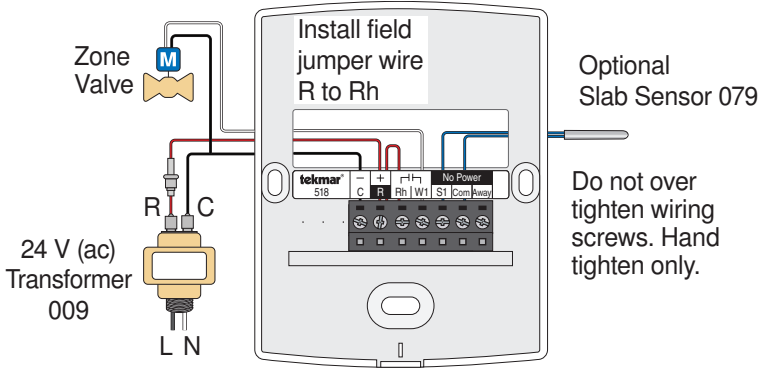

Wiring Center 315 or 316

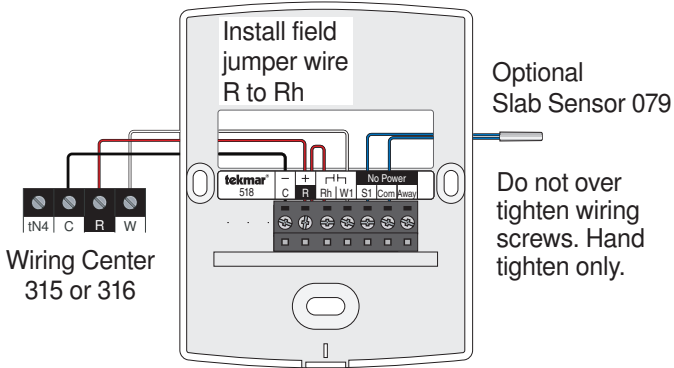

Relay 003

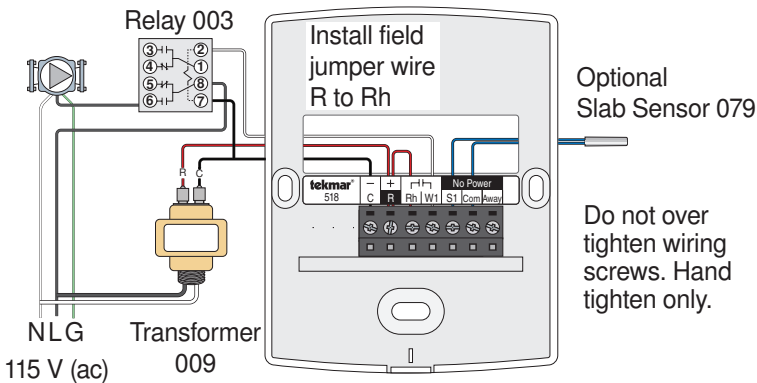

Thermostat Wiring

Switching Relay

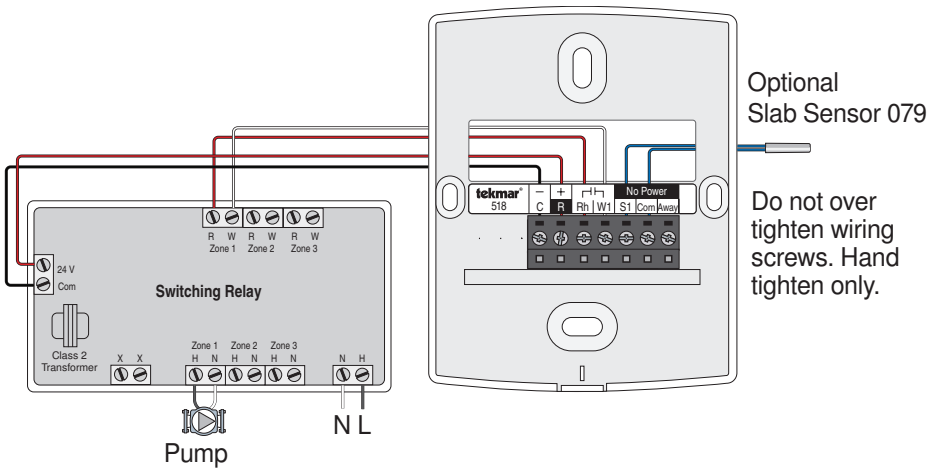

Testing the Thermostat Wiring

Testing the Power

If the thermostat display turns on, this indicates that the thermostat is operating correctly and there are no electrical issues. In the event that the display is permanently off:

1. Remove the thermostat front.
2. Use an electrical meter to measure voltage between the R and C wiring terminals. For AC power supplies the voltage should measure between 10 to 30 V (ac). For DC power supplies the voltage should measure between 10 to 30 V (dc).
3. If the voltage on the R and C wire terminations is continuous and the thermostat display is not on, the thermostat may have a fault. Contact your tekmar sales representative for assistance.

If the thermostat display initially powers on but later shuts off intermittently, there may be a short circuit from the W wire to ground, or the power supply is too small to power the load.

Testing the Heat Zone Output Wiring

1. Touch the Δ button and set the heating temperature above the current room temperature. Make sure the display does not flash "Max" if using a floor sensor.
2. When the "Heat On" symbol appears on the display, use an electrical meter to check for voltage on the W and C wires connected to the zone valve, wiring center, relay or switching relay. The electrical meter should read 10 to 30 V (ac) or (dc).
3. If the W and C wire have voltage, check the zone valve, wiring center, relay or pump to determine if the heat device is operating correctly.

User Interface

Home Screen

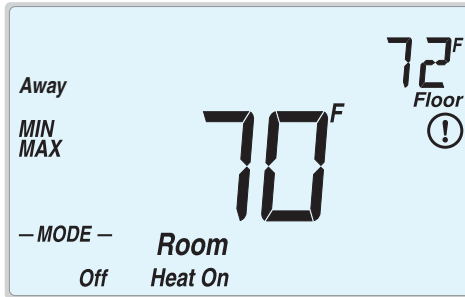

Symbols Description

Heat On	HEAT ON Heat is turned on.	MIN	MIN The floor is at or below the floor minimum temperature.
-MODE- Off	MODE OFF The heating system is off.	MAX	MAX The floor has reached the floor maximum temperature.
	WARNING SYMBOL Indicates an error is present.	Away	AWAY Operating at the away temperature.

Sequence of Operation

Heating Operation

Push the Δ or ∇ button to select a preferred temperature setting. The Heat On symbol is shown on the display when the thermostat is heating. The heat can cycle on and off within +/- 1.5°F (1°C) of the temperature setting.

The floor and air heating can be shut off by holding the ∇ button until Set Room is Off. To resume heating when the Mode is Off, press the Δ button to navigate to the Mode setting, then press the Δ button to select Mode Heat. The thermostat will resume heating at the last previously set temperature.

The away feature saves energy by heating to a lower temperature while you are away. To activate Away, short the Away and Com wiring terminals together.

Air Temperature Only

If there is only an air temperature sensor (no floor sensor), the thermostat operates to control your desired air temperature.

Floor Temperature Only

If the air sensor has been disabled, the thermostat will only maintain floor temperature and ignore air temperature. This operation is recommended for areas such as bathrooms to ensure that tile floors are warm to the touch.

Floor and Air Temperature







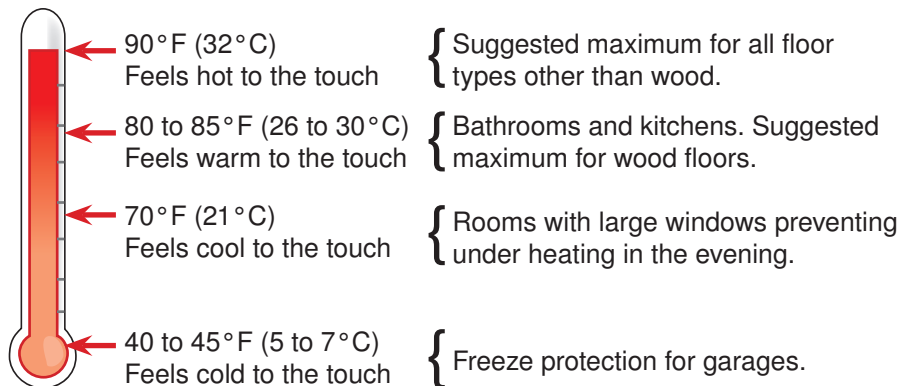



If the air sensor is turned on and a floor sensor is connected, the thermostat will maintain the desired air temperature as well as a minimum floor temperature.

This operation is recommended for areas with large windows that allow the sun to shine into a room and keep it warm without the need for heat. This can allow the floors to cool off during the afternoon. When the sun goes down, it can take a long time for the floors to get warm again. This may cause the room to cool off too much in the early evening. A floor minimum setting can help with this condition by maintaining a floor minimum temperature. Keep in mind the floor minimum temperature will override the air temperature, and if set too high, may overheat the room.

This operation is also recommended for rooms with hardwood floors. Setting floor minimum and maximum temperatures is a way of enhancing the comfort of the living space while protecting floor coverings.







Programmable Settings

Setting	Display
User settings. Press the Δ and ∇ buttons together for 3 seconds to enter and advance to the next setting.	
MODE Select heat or off.	
Range: HEAT, OFF	Default: HEAT
UNITS Select the temperature units.	
Range: °F or °C	Default: °F
LIGHT Select when the display back light should operate. Auto operates the backlight for 30 seconds after a keystroke.	
Range: OFF, AUTO, ON	Default: AUTO
SET FLOOR Set the floor minimum temperature. Available when an auxiliary floor sensor is connected and the built-in room sensor is on.	
Range: OFF, 40 to 122°F (4.5 to 50.0°C)	Default: 72°F (22.0°C)
TYPE Device Type number. Hold the Δ button to view the software version.	
ESCAPE Release the Δ and ∇ buttons to return to the home screen.	
Installer settings. Press the Δ and ∇ buttons together for 5 more seconds.	
AUXILIARY SENSOR Select the type of auxiliary sensor. Available when an auxiliary sensor is automatically detected.	
Range: NONE = no auxiliary sensor, ROOM = Indoor Sensor, FLOOR = Slab Sensor, OUT = Outdoor Sensor	Default: OFF
ROOM SENSOR Select if the built-in room temperature sensor is on or off. The built-in room sensor can only be disabled when an auxiliary room or slab sensor is connected.	
Range: ON or OFF	Default: ON
SET FLOOR MAXIMUM Set the floor maximum temperature in order to protect the floor covering. Suggested settings: Tile = 90°F (32°C), Wood Floor = 85°F (29°C)	
Range: 40 to 122°F (4.5 to 50.0°C), OFF	Default: 85°F (29.5°C)
SET AWAY Set the away temperature.	
Range: OFF, 40 to 122°F (4.5 to 35.0°C)	Default: 50°F (10.0°C)
ESCAPE Release the Δ and ∇ buttons to return to the home screen.	

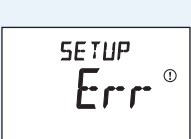
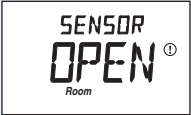
Troubleshooting

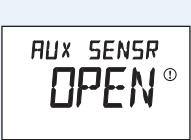
Error Messages

Error Message	Description
	<p>SETUP MENU SAVE ERROR</p> <p>The thermostat failed to read the Programmable Settings from memory and has reloaded the factory default settings. The thermostat stops normal operation until all Programmable Settings are checked except to provide freeze protection.</p>
	<p>ROOM SENSOR OPEN CIRCUIT ERROR</p> <p>The built-in air temperature sensor has an open circuit fault. Do not confuse this error with the auxiliary room sensor short circuit error. This error cannot be field repaired. Contact your wholesaler or tekmar sales representative for details on repair procedures.</p>
	<p>ROOM SENSOR SHORT CIRCUIT ERROR</p> <p>The built-in air temperature sensor has a short circuit fault. Do not confuse this error with the auxiliary room sensor short circuit error. This error cannot be field repaired. Contact your wholesaler or tekmar sales representative for details on repair procedures.</p>
	<p>AUXILIARY SENSOR OPEN CIRCUIT ERROR</p> <p>The auxiliary sensor has an open circuit. Check for loose or damaged wires. Locate and repair the problem as described in the sensor Installation & Operation Manual (070_D, 079_D). The error clears once the auxiliary sensor fault is corrected. If the auxiliary sensor was intentionally removed, power the thermostat down and up to clear the error.</p>
	<p>AUXILIARY SENSOR SHORT CIRCUIT ERROR</p> <p>The auxiliary sensor has a short circuit. Check for damaged wires. Locate and repair the problem as described in the sensor Installation & Operation Manual (070_D, 079_D). The error clears after the auxiliary sensor fault is corrected.</p>

Frequently Asked Questions

Symptom	Look for...	Corrective Action
Display powering on and off.	Measure voltage at wiring terminals R and C.	The power supply transformer may have limited VA capacity. A transformer with a larger VA rating is recommended.
Thermostat does not heat.	Mode Off	Thermostat must be in Mode Heat in order to provide heating.

Technical Data

Thermostat 518 <i>One Stage Heat</i>	
Literature	518_C, 518_D, 518_Q, 518_U
Control	Microprocessor control. This is not a safety (limit) control
Packaged weight	0.53 lb. (240 g)
Dimensions	3-11/16" H x 3" W x 15/16" D (94 x 76 x 24 mm)
Enclosure	White PVC plastic, NEMA Type 1
Approvals	Meets Class B: ICES & FCC Part 15
Ambient conditions	Indoor use only, 32 to 122°F (0 to 50°C), RH ≤90% non-condensing
Power supply	10 to 30 V (ac/dc), 50/60 Hz, 1.8 VA standby, 56 VA max fully loaded, Class 2
Relay	30 V (ac/dc) 2 A, Class 2 circuits
Sensor	NTC thermistor, 10 kΩ @ 77°F (25°C ±0.2°C) β=3892
– Included	None
– Optional	tekmar type # 070, 072, 073, 076, 077, 079, 084

Limited Warranty and Product Return Procedure

Limited Warranty *The liability of tekmar under this warranty is limited. The Purchaser, by taking receipt of any tekmar product ("Product"), acknowledges the terms of the Limited Warranty in effect at the time of such Product sale and acknowledges that it has read and understands same.*

The tekmar Limited Warranty to the Purchaser on the Products sold hereunder is a manufacturer's pass-through warranty which the Purchaser is authorized to pass through to its customers. Under the Limited Warranty, each tekmar Product is warranted against defects in workmanship and materials if the Product is installed and used in compliance with tekmar's instructions, ordinary wear and tear excepted. The pass-through warranty period is for a period of twenty-four (24) months from the production date if the Product is not installed during that period, or twelve (12) months from the documented date of installation if installed within twenty-four (24) months from the production date.

The liability of tekmar under the Limited Warranty shall be limited to, at tekmar's sole discretion: the cost of parts and labor provided by tekmar to repair defects in materials and / or workmanship of the defective product; or to the exchange of the defective product for a warranty replacement product; or to the granting of credit limited to the original cost of the defective product, and such repair, exchange or credit shall be the sole remedy available from tekmar, and, without limiting the foregoing in any way, tekmar is not responsible, in contract, tort or strict product liability, for any other losses, costs, expenses, inconveniences, or damages, whether direct, indirect, special, secondary, incidental or consequential, arising from ownership or use of the product, or from defects in workmanship or materials, including any liability for fundamental breach of contract.

The pass-through Limited Warranty applies only to those defective Products returned to tekmar during the warranty period. This Limited Warranty does not cover the cost of the parts or labor to remove or transport the defective Product, or to reinstall the repaired or replacement Product, all such costs and expenses being subject to Purchaser's agreement and warranty with its customers.

Any representations or warranties about the Products made by Purchaser to its customers which are different from or in excess of the tekmar Limited Warranty are the Purchaser's sole responsibility and obligation. Purchaser shall indemnify and hold tekmar harmless from and against any and all claims, liabilities and damages of any kind or nature which arise out of or are related to any such representations or warranties by Purchaser to its customers.

The pass-through Limited Warranty does not apply if the returned Product has been damaged by negligence by persons other than tekmar, accident, fire, Act of God, abuse or misuse; or has been damaged by modifications, alterations or attachments made subsequent to purchase which have not been authorized by tekmar; or if the Product was not installed in compliance with tekmar's instructions and / or the local codes and ordinances; or if due to defective installation of the Product; or if the Product was not used in compliance with tekmar's instructions.

THIS WARRANTY IS IN LIEU OF ALL OTHER WARRANTIES, EXPRESS OR IMPLIED, WHICH THE GOVERNING LAW ALLOWS PARTIES TO CONTRACTUALLY EXCLUDE, INCLUDING, WITHOUT LIMITATION, IMPLIED WARRANTIES OF MERCHANTABILITY AND FITNESS FOR A PARTICULAR PURPOSE, DURABILITY OR DESCRIPTION OF THE PRODUCT, ITS NON-INFRINGEMENT OF ANY RELEVANT PATENTS OR TRADEMARKS, AND ITS COMPLIANCE WITH OR NON-VIOLATION OF ANY APPLICABLE ENVIRONMENTAL, HEALTH OR SAFETY LEGISLATION; THE TERM OF ANY OTHER WARRANTY NOT HEREBY CONTRACTUALLY EXCLUDED IS LIMITED SUCH THAT IT SHALL NOT EXTEND BEYOND TWENTY-FOUR (24) MONTHS FROM THE PRODUCTION DATE, TO THE EXTENT THAT SUCH LIMITATION IS ALLOWED BY THE GOVERNING LAW.

Product Warranty Return Procedure All Products that are believed to have defects in workmanship or materials must be returned, together with a written description of the defect, to the tekmar Representative assigned to the territory in which such Product is located. If tekmar receives an inquiry from someone other than a tekmar Representative, including an inquiry from Purchaser (if not a tekmar Representative) or Purchaser's customers, regarding a potential warranty claim, tekmar's sole obligation shall be to provide the address and other contact information regarding the appropriate Representative.

WARNING: This product contains chemicals known to the State of California to cause cancer and birth defects or other reproductive harm.
For more information: Watts.com/prop65

tekmar[®]

A WATTS Brand

All specifications are subject to change without notice

Tel: (250) 545-7749 • Fax: (250) 984-0815
tekmarControls.com